

Size Charts

July 2024

Always A&L

A&L
WINDOWS | DOORS

Contents

- 4 **Boutique Bifold Windows**
- 5 **Boutique Bifold Doors**
- 6 **Boutique French Doors**
- 7 **Standard Sliding Doors**
- 8 **Standard Entertainer Sliding Doors**
- 9 **Boutique Sliding Doors**
- 10 **Standard Sliding Windows**
- 11 **Standard Sliding Windows**
- 12 **Standard Double Glazed Sliding Windows**
- 13 **Standard Awning Windows**
- 14 **Standard Armadale Awning Windows**
- 15 **Standard Georgian Awning Windows**
- 16 **Standard Overlooking Awning Windows**
- 17 **Standard Offset (Metro) Awning Windows**
- 18 **Standard Single Transom (Contempo) Awning Windows**
- 19 **Standard Multi Transom (Contempo) Awning Windows**
- 20 **Standard Top Transom Awning Windows MKII**
- 21 **Boutique Awning Windows**
- 22 **Boutique Awning Windows**
- 23 **Boutique Georgian Awning Windows**
- 24 **Boutique Armadale Awning Windows**
- 25 **Boutique Armadale Awning Windows**
- 26 **Boutique Offset (Metro) Awning Windows**
- 27 **Boutique Multi Transom (Contempo) Awning Windows**
- 28 **Boutique Multi Transom (Contempo) Awning Windows**
- 29 **Boutique Overlooking Awning Windows**
- 30 **Boutique Single Transom (Contempo) Awning Windows**
- 31 **Boutique Top Transom Awning Windows MKII**
- 32 **Boutique Fixed No Mullion Awning Windows**
Single Glazed
- 33 **Boutique Fixed No Mullion Awning Windows**
Double Glazed
- 34 **Boutique Fixed One Mullion Awning Windows**
Single Glazed
- 35 **Boutique Fixed One Mullion Awning Windows**
Double Glazed
- 36 **Boutique Fixed Two Mullion Awning Windows**
Single Glazed
- 37 **Boutique Fixed Two Mullion Awning Windows**
Double Glazed
- 38 **Boutique Fixed Three Mullion Awning Windows**
Single Glazed
- 39 **Boutique Fixed Three Mullion Awning Windows**
Double Glazed
- 40 **Boutique Heavy Duty Fixed No Mullion Windows**
Double Glazed Only, VIC & Sth NSW Only
- 41 **Boutique Heavy Duty Fixed One Mullion Windows**
Double Glazed Only, VIC & Sth NSW Only
- 42 **Standard Louvre Windows**
- 43 **Standard Louvre Windows**
- 44 **Standard Double Hung Windows**
- 45 **Standard Aluminium Door Frame & Window Combinations**
- 46 **Standard Timber Laundry Door Frame & Window Combinations**
- 47 **Standard Shaped Windows**
Ellipse & Full Circle Windows
- 48 **Standard Shaped Windows**
Radius Windows
- 49 **Standard Aluminium Entries**
Aluminium Hinged Doors & Aluminium Door Frames for Corinthian Panels
- 50 **Standard Aluminium Entries**
Aluminium Door Frames with Single Sidelights
- 51 **Standard Aluminium Entries**
Aluminium Door Frames with Double Sidelights
- 52 **Standard Timber Entries**
- 53 **Standard Timber Entries**
Timber Door Frames with Timber Single Sidelights
- 54 **Standard Timber Entries**
Timber Door Frames with Timber Double Sidelights
- 55 **Standard Timber Entries**
Timber Door Frames with Aluminium Single Sidelights
- 56 **Standard Timber Entries**
Timber Door Frames with Aluminium Double Sidelights
- 57 **Boutique & Standard Awning Windows**
Lineage Collection - Loft Series
- 58 **Boutique & Standard Armadale Awning Windows**
Lineage Collection - Loft Series
- 59 **Boutique & Standard Georgian Awning Windows**
Lineage Collection - Loft Series
- 60 **Boutique & Standard Awning Windows**
Lineage Collection - Newport Series
- 61 **Boutique & Standard Awning Windows**
Lineage Collection - Newport Series
- 62 **Boutique Armadale Awning Windows**
Lineage Collection - Newport Series
- 63 **Standard Armadale Awning Windows**
Lineage Collection - Newport Series

Contents

- 64 **Boutique Georgian Awning Windows**
Lineage Collection - Newport Series
- 65 **Standard Georgian Awning Windows**
Lineage Collection - Newport Series
- 66 **Standard Georgian Awning Windows**
Lineage Collection - Newport Series
- 67 **Boutique & Standard Awning Windows**
Lineage Collection - Gatsby Series
- 68 **Boutique & Standard Armadale Awning Windows**
Lineage Collection - Gatsby Series
- 69 **Boutique & Standard Georgian Awning Windows**
Lineage Collection - Gatsby Series
- 70 **Boutique Fixed No Mullion Windows**
Lineage Collection - Loft Series
- 71 **Boutique Fixed No Mullion Windows**
Lineage Collection - Newport Series
- 72 **Boutique Fixed No Mullion Windows**
Lineage Collection - Newport Series
- 73 **Boutique Fixed No Mullion Windows**
Lineage Collection - Gatsby Series
- 74 **Boutique Fixed One Mullion Windows**
Lineage Collection - Loft Series
- 75 **Boutique Fixed One Mullion Windows**
Lineage Collection - Newport Series
- 76 **Boutique Fixed One Mullion Windows**
Lineage Collection - Newport Series
- 77 **Boutique Fixed One Mullion Windows**
Lineage Collection - Gatsby Series
- 78 **Boutique Fixed Two Mullion Windows**
Lineage Collection - Loft Series
- 79 **Boutique Fixed Two Mullion Windows**
Lineage Collection - Newport Series
- 80 **Boutique Fixed Two Mullion Windows**
Lineage Collection - Newport Series
- 81 **Boutique Fixed Two Mullion Windows**
Lineage Collection - Gatsby Series
- 82 **Boutique Fixed Three Mullion Windows**
Lineage Collection - Loft Series
- 83 **Boutique Fixed Three Mullion Windows**
Lineage Collection - Newport Series
- 84 **Boutique Fixed Three Mullion Windows**
Lineage Collection - Newport Series
- 85 **Boutique Fixed Three Mullion Windows**
Lineage Collection - Gatsby Series
- 86 **Sliding Windows**
Lineage Collection - Loft Series
- 87 **Sliding Windows**
Lineage Collection - Newport Series
- 88 **Sliding Windows**
Lineage Collection - Newport Series
- 89 **Sliding Windows**
Lineage Collection - Gatsby Series
- 90 **Standard Sliding Doors**
Lineage Collection - Loft Series
- 91 **Standard Sliding Doors**
Lineage Collection - Loft Series
- 92 **Standard Sliding Doors**
Lineage Collection - Newport Series
- 93 **Standard Sliding Doors**
Lineage Collection - Newport Series
- 94 **Standard Sliding Doors**
Lineage Collection - Newport Series
- 95 **Standard Sliding Doors**
Lineage Collection - Gatsby Series
- 96 **Standard Sliding Doors**
Lineage Collection - Gatsby Series
- 97 **Boutique Sliding Doors**
Lineage Collection - Loft Series
- 98 **Boutique Sliding Doors**
Lineage Collection - Loft Series
- 99 **Boutique Sliding Doors**
Lineage Collection - Loft Series
- 100 **Boutique Sliding Doors**
Lineage Collection - Newport Series
- 101 **Boutique Sliding Doors**
Lineage Collection - Newport Series
- 102 **Boutique Sliding Doors**
Lineage Collection - Newport Series
- 103 **Boutique Sliding Doors**
Lineage Collection - Gatsby Series
- 104 **Boutique Sliding Doors**
Lineage Collection - Gatsby Series
- 105 **Boutique Sliding Doors**
Lineage Collection - Gatsby Series
- 106 **Boutique French Doors**
Lineage Collection - Loft Series
- 107 **Boutique French Doors**
Lineage Collection - Newport Series
- 108 **Boutique French Doors**
Lineage Collection - Gatsby Series

Boutique Bifold Windows

Code Prefix: WABF

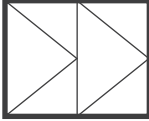
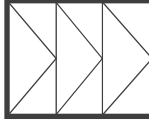
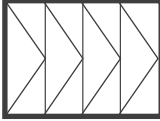
Size Code			15	18	27	27	36
	O/A Reveal Size NBR (mm)	O/A Reveal Size With Sill Reveal (mm)	1450	1810	2710	2710	3610
12	1200	1220					
14	1372	1392					
15	1543	1563					



Available Configurations:	2/0	3/0	3/0	4/0	4/0
	1/1	2/1	2/1	3/1	3/1
	0/2	1/2	1/2	2/2	2/2
		0/3	0/3	1/3	1/3
				0/4	0/4

Configuration shown

- Double Glazing option for all available sizes above
- Available With or Without a Bottom Reveal
- Only Available as Open Out

Boutique Bifold Doors

Code Prefix: DABF

Size Code		14	18	18	24	27	27	30	36	36	42	48	53	53	60
O/A Reveal Size (mm)		1450	1810	1810	2410	2710	2710	3010	3610	3610	4210	4810	5290	5290	6010
21	2110														
23	2370														



Available Configurations:	2/0	2/0	3/0	3/0	3/0	4/0	4/0	4/0	5/0	5/0	6/0	6/0	7/0	8/0
	0/2	0/2	2/1	2/1	2/1	3/1	3/1	3/1	4/1	4/1	5/1	5/1	6/1	7/1
			1/2	1/2	1/2	2/2	2/2	2/2	3/2	3/2	4/2	4/2	5/2	6/2
			0/3	0/3	0/3	1/3	1/3	1/3	2/3	2/3	3/3	3/3	4/3	5/3
						0/4	0/4	0/4	1/4	1/4	2/4	2/4	3/4	4/4
									0/5	0/5	1/5	1/5	2/5	3/5
											0/6	0/6	1/6	2/6
													0/7	1/7
														0/8

Configuration shown

Corner Door Options:

- Double Glazing option for all available sizes above
- Available Open Out Only
- Single action Bifold doors only available on certain configurations. Please check with Account Manager your further detail







Internal Corner
External Corner

Available with an ODD number of panels on each wing only, active panel must be selected

Available with EVEN panels on both wings (no active panel option)

Available with EVEN panels on one wing & ODD panels on the other wing (active panel on ODD wing only)

Code Prefix: DAFR

Size Code		06	08	09	10	11	12	15	17	19	21	xx	xx	xx	xx						
	O/A Reveal Size (mm)	648	768	898	1013	1113	1210	1450	1710	1940	2140	2913 (max)	3940 (max)	4713 (max)	5740 (max)						
	Panel Size	552	672	802	917	1017	552 x 2	672 x 2	802 x 2	917 x 2	1017 x 2	Variable	Variable	Variable	Variable						
	Combination	Single	Single	Single	Single	Single	Double	Double	Double	Double	Double	Variable with single door & sidelight	Variable with double door & single sidelight	Variable with single door double sidelight	Variable with double door & double sidelight						
21	2110																				
23	2370																				

- Double Glazing option for all available sizes above
- Available Open In or Open Out
- Available (STD) Hinged on Left, or (REV) Hinged on Right
- Maximum Fixed Panel size of 1800mm wide when Single Glazed
- Maximum Fixed Panel width when Double Glazed varies dependant on height required (check with your Sales Representative for availability)

Standard Sliding Doors

Code Prefix: DASL

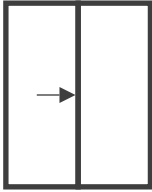
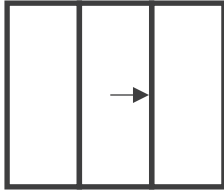
Size Code		14	18	21	24	27	30	32	36
	O/A Reveal Size (mm)	1450	1810	2170	2410	2687	3011	3227	3587
21	2110								
23	2365								

- Available (STD) Sliding Left to Right, or (REV) Sliding Right to Left
- Centre Sliding Option Available for 3 Panel Door, Left to Right Only
- Double Glazing option for all available sizes above
- Accessible Door Sill available in 2 panel sliding door configuration, up to 27 wide (2676mm)

Code Prefix: DASL Suite: BP

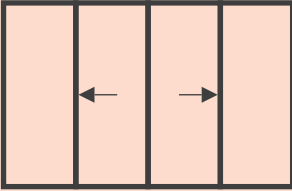
Size Code		28	29	30	36	42	48
	O/A Reveal Size (mm)	2855	2990	3015	3575	4295	4775
21	2110						
23	2365						

- Available (LHA) Left Hand Active, or (RHA) Right Hand Active
- Double Glazing option for all available sizes above
- Available in QLD & Nth NSW Only
- Available in VIC & Sth NSW Only
- Accessible Door Sill available in 4 panel sliding door configuration, up to 48 wide (4775mm)

Please Note: Size charts are provided as a guide only, images may not reflect the exact proportions of the product you specify. Images represent the external view of the product and refer to A&L's standard offering for N2 areas. Specific size limitations or alternative options may be applicable for other wind categories or account customer specific ranges. The A&L website Terms of Use apply to this document. ALNAT0626/0724 July 2024.

Standard Entertainer Sliding Doors

Code Prefix: DASE

Code Prefix: DASE Suite: BP

Size Code		18	21	24	27	30	32	36	42	48	53	
	O/A Reveal Size (mm)	1810	2133	2394	2673	2997	3213	3573	4217	4739	5297	
21	2110											
23	2365											

- 3 Panel Door Available (STD) Sliding Left to Right, or (REV) Sliding Right to Left
 - 6 Panel Door Available (LHA) Left Hand Active, or (RHA) Right Hand Active
 - Double Glazing option for all available sizes above
- Available in QLD & Nth NSW Only

Corner Door Option:

Available in QLD & Nth NSW Only (3 Panel Option Only)

Boutique Sliding Doors

Code Prefix: DASL

Code Prefix: DASL Suite: BP

Size Code		14	18	21	24	27	30	32	36	28	36	42	48	53	59
	O/A Reveal Size (mm)	1450	1810	2170	2410	2710	3010	3250	3610	2824	3544	4264	4744	5344	5944
21	2110														
23	2370														
26	2660														

- 2 Panel Door Available (STD) Sliding Left to Right, or (REV) Sliding Right to Left
- 4 Panel Bi-Parting Door Available (LHA) Left Hand Active, or (RHA) Right Hand Active

 Size not available Double Glazed.

Code Prefix: DASE

Code Prefix: DASE Suite: BP

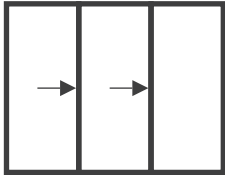
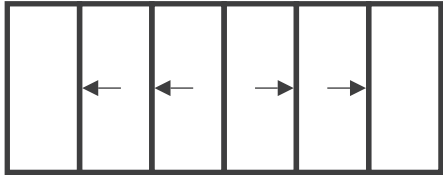
Size Code		21	27	30	32	36	40	45	48	54	42	53	64
	O/A Reveal Size (mm)	2133	2673	2994	3213	3573	4023	4473	4833	5373	4188	5268	6348
21	2110												
23	2370												
26	2660												

- 3 Panel Door Available (STD) Sliding Left to Right, or (REV) Sliding Right to Left
- 6 Panel Door Available (LHA) Left Hand Active, or (RHS) Right Hand Active

 Size not available Double Glazed

Corner Door Option:

- Must be either EVEN or ODD number panels on both wings

Code Prefix: WASL

Size Code	O/A Reveal Size (mm)	06	09	12	15	18	21	24	18	21	24	27	30
05	514												
09	854												
10	1027												
12	1200												
14	1372												
15	1543												
18	1800												
20	2057												
21	2110												
23	2315												
24	2368												

- 2 Panel Available (STD) Sliding Left to Right, (REV) Sliding Right to Left, or (FXD) All Fixed Panels
- 2 Panel Wide with Transom and Low Light Available (3S) 2 Panels above Sliding Left to Right, (3R) 2 Panels above Sliding Right to Left, or (3F) All Fixed Panels
- 3 Panel Wide Available (STD) Equal Panels, (QHQ) Quarter/Half/Quarter, (SSS) Set Sash Size (sash width selected from standard sizes), or (FXD) All Fixed Panels (standard config. only)

QHQ Option:

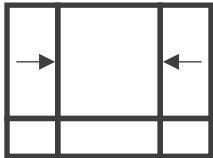

Available in QLD & Nth NSW Only

See separate chart for Double Glazed Sliding Window sizes

Please Note: Size charts are provided as a guide only, images may not reflect the exact proportions of the product you specify. Images represent the external view of the product and refer to A&L's standard offering for N2 areas. Specific size limitations or alternative options may be applicable for other wind categories or account customer specific ranges. The A&L website Terms of Use apply to this document. ALNAT0626/0724 July 2024.

Standard Sliding Windows

Code Prefix: WASL

Code Prefix: WASL Suite: BP

Size Code		03	06	09	12	15	18
	O/A Reveal Size (mm)	330	610	850	1210	1450	1810
05	514						
09	854						
10	1027						
12	1200						
14	1372						
15	1543						
18	1800						
20	2057						
21	2110						
23	2315						
24	2368						

15	18	21	24	27	30
1450	1810	2170	2410	2710	3010

- Single Panel Available as Fixed Only
- 4 Panel Wide Available (STD) All Equal Panels, or (FXD) All Fixed Panels

 Not Available

 Available in QLD & Nth NSW Only

See separate chart for Double Glazed Sliding Window sizes

Standard Double Glazed Sliding Windows

(VIC & Sth NSW Only)

Code Prefix: WASI

Code Prefix: WASI Suite: BP

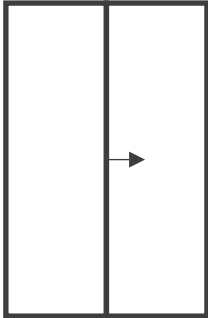
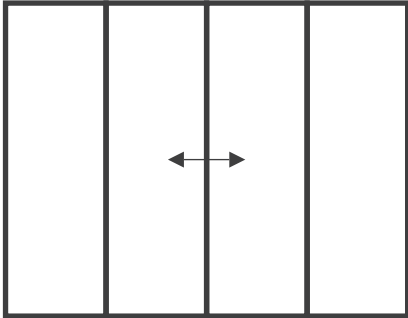
Size Code			09	12	15	18	21	24	18	21	24	27	30	34	
	O/A Reveal Size NBR (mm)	O/A Reveal Size with Sill (mm)	850	1210	1450	1810	2170	2410	1810	2170	2410	2710	3010	3370	
05	514	534													
09	854	874													
10	1027	1047													
12	1200	1220													
14	1372	1392													
15	1543	1563													
18	1800	1820													

- Available with any Glass Combination up to 18mm overall
- 2 Panel Available (STD) Left to Right, (REV) Right to Left
- No Fixed Option Available

Code Prefix: WAAW

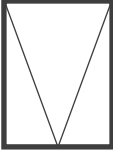
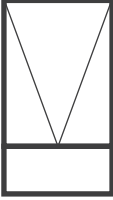
Size Code	O/A Reveal Size (mm)	03 330 (Fixed Only)	04 450	06 610	09 850	12 1210	12 1198	15 1450	18 1810	21 2170	24 2398	18 1810	21 2170	24 2398	27 2704		
05	514																
09	854																
10	1027																
12	1200																
14	1372																
15	1543																
18	1800																
20	2057																
23	2315																

- Single Panel Wide Available (STD) Single Sash, or (FXD) All Fixed Panels
- 2 Panel Wide Available (STD) Opening Sash on Left, (REV) Opening Sash on Right, (FXD) All Panels Fixed, or (DS) Double Sash:

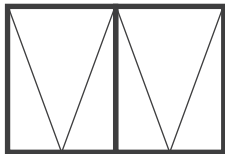

- Double Glazing option for all available sizes above, with 32mm sash frame thickness
- Standard 25mm Sash frame thickness, option to upgrade to:
 - 53mm Wideline Sash
 - 38mm Thermally Broken Slimline Sash (VIC Only)

- 3 Panel Wide Available (STD) Equal Sash on Left and Right, (FXD) All Fixed Panels, (TS) Triple Sash (Standard Configuration Only), (SSS) Set Sash Sizes (sashes at a nominated standard width either 06 - 561mm, 09 - 801mm or 15 - 687mm wide), (QH) Quarter/Half/Quarter, or (CS) Centre Sash (Standard Configuration Only)

(STD) Equal Sash on Left and Right:

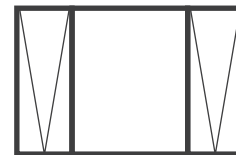

Standard Armadale Awning Windows

Code Prefix: WAAW Suite: AR

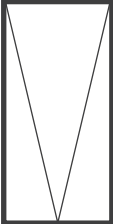
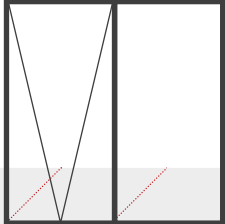
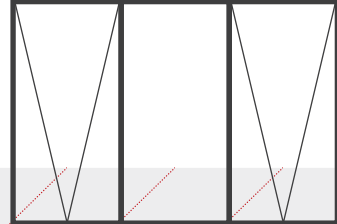
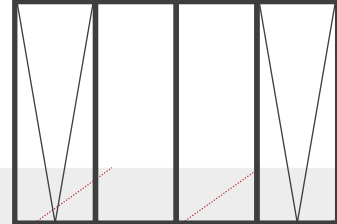
Size Code		03	04	05	06	09	12	12	15	18	18	21	24	27	21	24	27		
	O/A Reveal Size (mm)	330 (Fixed Only)	450	490	610	850	1210	1198	1450	1810	1810	2170	2398	2704	2170	2398	2704		
18	1800																		
20	2057																		
23	2315																		

- Single Panel Wide Available (STD) Single Sash, or (FXD) Up to 09 wide all heights (Single Glazed Only, Victoria Only)
- 2 Panel Wide Available (STD) Opening Sash on Left, (REV) Opening Sash on Right, or (DS): Double Sash:

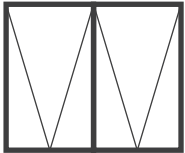



















- 3 Panel Wide Available (STD) Equal Sash on Left and Right
- 4 Panel Wide Available (STD) Equal Sash on Left and Right, 2 Centre Panels Fixed
- 53mm Wideline Sash frame thickness as standard
- **Double Glazing option for all available sizes above**

 Not Available

Standard Georgian Awning Windows

Code Prefix: WAAW Suite: GS

Size Code		09	12	15	18	21	24
	O/A Reveal Size (mm)	850	1210	1450	1810	2170	2398
	Sash Widths (m)	801	1161	449	561	561	561
10	1027						
12	1200						
14	1372						
15	1543						
18	1800						
20	2057						
23	2315						





- 53mm Wideline Sash frame thickness as standard
- **Double Glazing option for all available sizes above**

 Not Available

Please Note: Size charts are provided as a guide only, images may not reflect the exact proportions of the product you specify. Images represent the external view of the product and refer to A&L's standard offering for N2 areas. Specific size limitations or alternative options may be applicable for other wind categories or account customer specific ranges. The A&L website Terms of Use apply to this document. ALNAT0626/0724 July 2024.

Standard Overlooking Awning Windows

Code Prefix: WAAW Suite: OL

Size Code		06	09	12	15	18	21	24	27	
O/A Reveal Size (mm)		610	850	1210	1450	1810	2170	2398	2704	
Sash Height (mm)										
10	1027									
12	1200									
14	1372									
15	1543									393
18	1800									
20	2057									
21	2110									

- Single Panel Wide Available (STD) Single Sash, or (FXD) All Fixed Panels
- 2 Panel Wide Available (STD) 2 Sashes Above, (3 Light) 1 Sash Above, or (FXD) All Fixed Panels
- 3 Panel Wide Available (STD) 3 Sashes Above, or (FXD) All Fixed Panels
- 53mm Wideline Sash frame thickness as standard
- **Double Glazing option for all available sizes above**

■ Available in QLD & Nth NSW Only

Standard Offset (Metro) Awning Windows

Code Prefix: WAAW Suite: OS (Offset)

Suite: OST (Offset Transom)

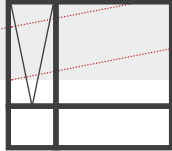
Size Code		15	18	21	15	18	21
	O/A Reveal Size (mm)	1450	1810	2170	1450	1810	2170
	Sash Width (mm)	449	561	801	449	561	801
14	1372			Not Available			
15	1543						
18	1800						
20	2057						

- Single Panel High Available (STD) Sash on Left, (REV) Sash on Right, or (FXD) All Fixed Panels
- 2 Panel High Available (STD) 1 Sash on Left above Transom, (REV) 1 Sash on Right above Transom, or (FXD) All Fixed Panels
- 53mm Wideline Sash frame thickness as standard
- **Double Glazing option for all available sizes above**

 Not Available

Standard Single Transom (Contempo) Awning Windows

Code Prefix: WAAW Suite: ST

Size Code		03	06	09	12	15	18	
O/A Reveal Size (mm)		330 (Fixed Only)	610	850	1210	1450	1810	
Sash Height (mm)								
15	1543							473
18	1800							561
20	2057							646
23	2315							541

- 53mm Wideline Sash frame thickness as standard
- **Double Glazing option for all available sizes above**
- **Available in VIC & Sth NSW Only**

 Not Available

Standard Multi Transom (Contempo) Awning Windows

Code Prefix: WAAW Suite: MT



Size Code		15	18	04	06	09	12	15	18	04	06	09	12	15	18	
	O/A Reveal Size (mm)	1450	1810	450	610	850	1210	1450	1810	450	610	850	1210	1450	1810	
05	514															
10	1027															
12	1200															
14	1372															
14	1372															
15	1543															
18	1800															
20	2057															
23	2315															

- Single Panel High Available (STD) Single Sash, or (FXD) Fixed
- 2-4 Panel High Available with Sash or Fixed Panel in any position
- 53mm Wideline Sash frame thickness as standard
- **Double Glazing option for all available sizes above**

 Not Available

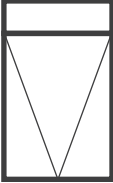

Standard Top Transom Awning Windows MKII

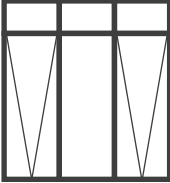
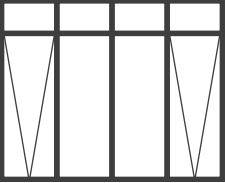
Code Prefix: WAAW Suite: TT

Size Code			06	09	12	12	15	18	21	24	18	21	24	27	21	24		
O/A Reveal Size (mm)			610	850	1210	1198	1450	1810	2170	2398	1810	2170	2398	2704	2170	2398		
Sash Height (mm)																		
15	1543	1240																
18	1800	1497																
20	2057	1754																

- Transom is positioned approximately 268mm from top of head to centre of transom, visible glass area will differ from the Boutique range due to differences in the sections
- Single Panel Wide Available (STD) 1 Sash below Transom, or (FXD) All Fixed Panels
- 2 Panel Wide Available (STD) 1 Sash below Transom Left, (REV) 1 Sash below Transom Right, (DS) Double Sash below Transom, or (FXD) All Fixed Panels
- 3 Panel Wide Available (STD) Equal Panels with Sash Bottom Left and Sash Bottom Right, (TS) Equal Panels with 3 Sashes below Transom, (FXD) All Fixed Panels
- 4 Panel Wide Available (STD) Equal Panels with Sash Bottom Left and Sash Bottom Right, or (FXD) All Fixed Panels
- 53mm Wideline Sash frame thickness as standard
- **Double Glazing option for all available sizes above**

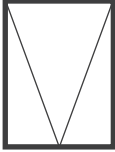
 Not Available

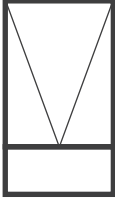
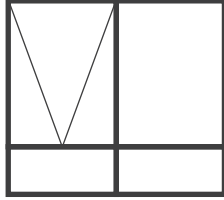
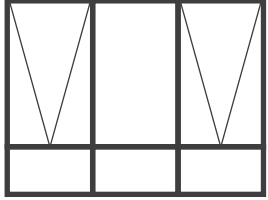
Size Code	O/A Reveal Size (mm)	04	06	09	12	12	15	18	21	24	18	21	24	27	
05	514	450	610	850	1210	1210	1450	1810	2170	2398	1810	2170	2398	2704	
09	854														
10	1027														
12	1200														
14	1372														
15	1543														
18	1800														
20	2057														
21	2110														
23	2315														

- Single Panel Wide Available (STD) Single Sash, or (FXD) All Fixed Panels
- 2 Panel Wide Available (STD) Opening Sash on Left, (REV) Opening Sash on Right, (FXD) All Panels Fixed, or (DS) Double Sash:

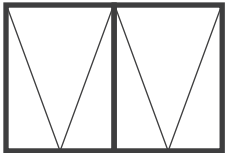

- 53mm Wideline Sash frame thickness as standard
- Double Glazing option for all available sizes above

- 3 Panel Wide Available (STD) Equal Sash on Left and Right, (FXD) All Fixed Panels, (TS) Triple Sash (Standard Configuration Only), (SSS) Set Sash Sizes (sashes at a nominated standard width either 06 - 561mm or 15 - 687mm wide), or (QH) Quarter/Half/Quarter

(STD) Equal Sash on Left and Right:

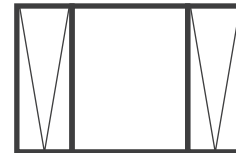

Boutique Awning Windows

Code Prefix: WAAW Suite: BTP

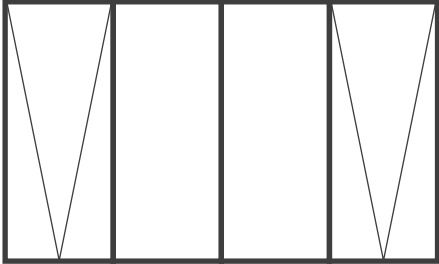
Size Code		15	18	21	24	27	30	36	40	48	
	O/A Reveal Size (mm)	1450	1810	2170	2410	2710	3010	3610	4000	4810	
05	514										
12	1200										
14	1372										
15	1543										

- Available (STD) Equal Panels, 1 Sash on Each Side, (DS) Double Centre Sashes, (QS) Quadruple Sash, or (FXD) All Fixed Panels
- 1450 Wide Only Available (FXD) All Fixed Panels
- 53mm Wideline Sash frame thickness as standard
- Double Glazing option for all available sizes above

 Not Available

Boutique Georgian Awning Windows

Code Prefix: WAAW Suite: BTP - GS

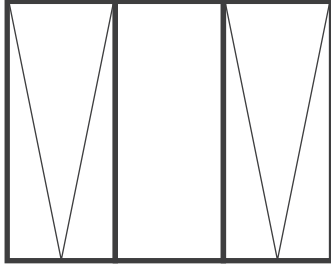
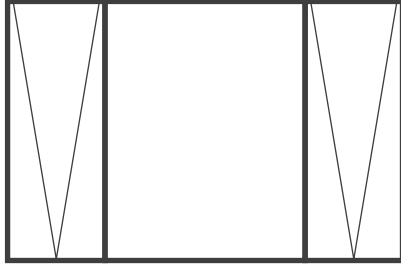
Size Code		09	12	18	21	24	27	30	36
O/A Reveal Size (mm)		850	1210	1810	2170	2410	2710	3010	3610
Sash Width (mm)		768	1128	384	474	534	609	684	834
10	1027								
12	1200								
14	1372								
15	1543								
18	1800								
20	2057								
23	2315								

- Single Panel Available (STD) Single Sash with GS Bar
- 3 Panel Wide Available (STD) Quarter/Half/Quarter

Code Prefix: WAAW Suite: BTP - GST

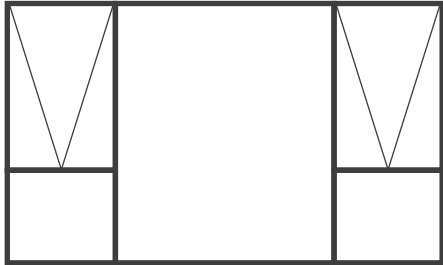
Size Code		18	21	24	27	30	36
O/A Reveal Size (mm)		1810	2170	2410	2710	3010	3610
Sash Width (mm)		384	474	534	609	684	834
18	1800						
20	2057						
23	2315						

- Available (STD) Quarter/Half/Quarter with Sash above Transom Left and Right, Full Height Fixed Panel in Centre
- 53mm Wideline Sash frame thickness as standard

 Size not available Double Glazed

Code Prefix: WAAW Suite: BTP - AR

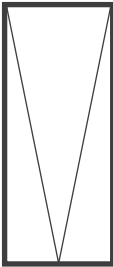
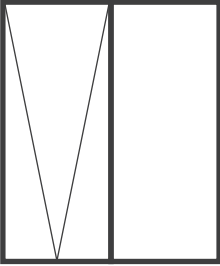
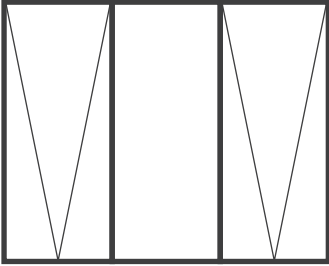
Size Code		04	06	09	12	09	12	15	18	21	24	15	18	21	24	27	30	36	
	O/A Reveal Size (mm)	450	610	850	1210	850	1210	1450	1810	2170	2410	1450	1810	2170	2410	2710	3010	3610	
18	1800																		
20	2057																		
21	2110																		
23	2315																		
24	2370																		

- Single Panel Available (STD) Single Sash
- 2 Panel Available (STD) Opening Sash on Left, (REV) Opening Sash on Right, or (DS) Double Sash
- 3 Panel Available (STD) Equal Panels, Sashes on Left and Right, (TS) Triple Sash, or (CS) Centre Sash
- 53mm Wideline Sash frame thickness as standard
- Double Glazing option for all available sizes above

Boutique Armadale Awning Windows

Code Prefix: WAAW Suite: BTP - ART

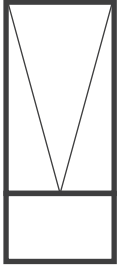
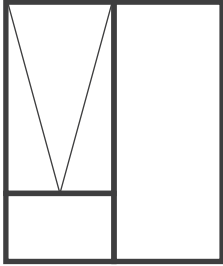
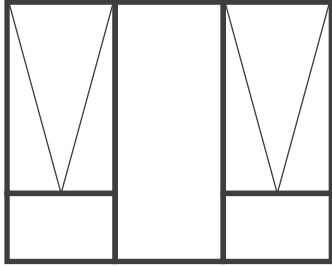
Size Code		04	06	09	12	09	12	15	18	21	24	15	18	21	24	27	30	36	
	O/A Reveal Size (mm)	450	610	850	1210	850	1210	1450	1810	2170	2410	1450	1810	2170	2410	2710	3010	3610	
18	1800																		
20	2057																		
21	2110																		
23	2315																		
24	2370																		

- Single Panel Wide Available (STD) Single Sash above Transom
- 2 Panel Wide Available (STD) Opening Sash above Transom on Left, (REV) Opening Sash above Transom on Right
- 3 Panel Wide Available (STD) Equal Panels with Sash on Left and Right above Transom
- 53mm Wideline Sash frame thickness as standard
- Double Glazing option for all available sizes above



Boutique Offset (Metro) Awning Windows

Code Prefix: WAAW Suite: BTP - OS

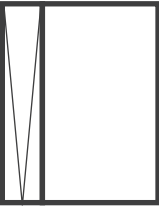
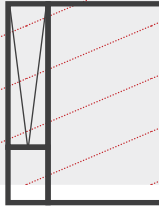
Code Prefix: WAAW Suite: BTP - OST



	Size Code	15	18	21	24	27	30	36	15	18	21	24	27	30
	O/A Reveal Size (mm)	1450	1810	2170	2410	2710	3010	3610	1450	1810	2170	2410	2710	3010
	Sash Width (mm)	414	534	654	734	834	934	1124	414	534	654	734	834	934
05	514													
10	1027													
12	1200													
14	1372													
15	1543													
18	1800													
20	2057													
23	2315													

- 1 Panel High Available (STD) Sash on Left, or (REV) Sash on Right
- 2 Panel High Available (STD) Sash on Left above Transom, (REV) Sash on Right above Transom
- 53mm Wideline Sash frame thickness as standard

-  Size not available Double Glazed
-  Not Available

Boutique Multi Transom (Contempo) Awning Windows

Code Prefix: WAAW Suite: BTP - MT

Size Code		06	09	12	15	18	21	24	27
	O/A Reveal Size (mm)	610	850	1210	1450	1810	2170	2410	2710
05	514								
07	700								
10	1027								
12	1200								
14	1372								
14	1372								
15	1543								
18	1800								
20	2057								
20	2057								
23	2315								
24	2370								

- Single Panel High Available (STD) Single Sash, or (FXD) Fixed
- 2-4 Panel High Available with Sash or Fixed Panel in any position
- 53mm Wideline Sash frame thickness as standard
- Sashes 2170mm wide and above require catches fitted to jambs
- Double Glazing option for all available sizes above

 Not Available

Boutique Multi Transom (Contempo) Awning Windows

Code Prefix: WAAW Suite: BTP - MT

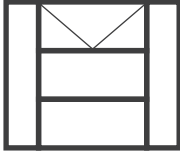
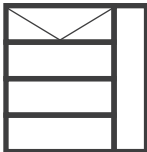
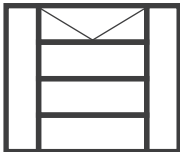
Size Code		21	24	27	27	27
O/A Reveal Size (mm)		2170	2410	2710	2710	2710
15	1543					
18	1800					
20	2057					
23	2315					

- 2 Panel Wide Available (STD) Sash Top Left with Full Height Fixed Panel Right, (REV) Sash Top Right with Full Height Fixed Panel Left
- 3 Panel Wide Available (STD) Sash Top Centre
- All Available with a Sash or Fixed Panel in any/all positions, excluding Fixed Sidelights
- 53mm Wideline Sash frame thickness as standard
- Double Glazing option for all available sizes above

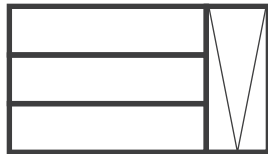

Sash Size in vertical position:

- Maximum 2315 high x 1210 wide
- Minimum 300 high x 450 wide



Sash Size in horizontal position:

- Maximum 700 high x 1810 wide
- Minimum 300 high x 450 wide

Boutique Overlooking Awning Windows

Code Prefix: WAAW Suite: BTP - OL

Size Code			06	09	12	15	18	21	24	15	18	21	24	27		
	O/A Reveal Size (mm)	Sash Height (mm)	610	850	1210	1450	1810	2170	2398	1450	1810	2170	2398	2704		
10	1027	370														
12	1200															
14	1372															
15	1543															
18	1800															
20	2057															
23	2315															

- Single Panel Wide Available (STD) Single Sash, or (FXD) All Fixed Panels
- 2 Panel Wide Available (STD) 2 Sashes Above, (3 Light) 1 Sash Above, or (FXD) All Fixed Panels
- 3 Panel Wide Available (STD) 3 Sashes Above, or (FXD) All Fixed Panels
- 53mm Wideline Sash frame thickness as standard
- **Double Glazing option for all available sizes above**

 Not Available

Boutique Single Transom (Contempo) Awning Windows

Code Prefix: WAAW Suite: BTP - ST



Size code			09	15	18	21
O/A Reveal Size (mm)			850	1450	1810	2170
Sash Height (mm)						
15	1543	460				
18	1800	545				
20	2057	631				
23	2315	525				

- 53mm Wideline Sash frame thickness as standard
- Double Glazing option for all available sizes above
- **Available in VIC & Sth NSW Only**

 Not Available

Boutique Top Transom Awning Windows MKII

Code Prefix: WAAW Suite: BTP - TT

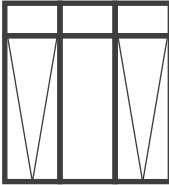
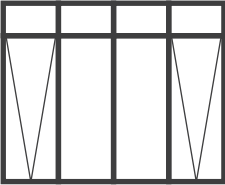
Size Code			06	09	12	12	15	18	21	24	15	18	21	24	27	18	21	24	27
	O/A Reveal Size (mm)		610	850	1210	1210	1450	1810	2170	2410	1450	1810	2170	2410	2710	1810	2170	2410	2710
	Sash Height (mm)																		
15	1543	1217																	
18	1800	1474																	
20	2057	1731																	

- Transom is positioned approximately 268mm from top of head to centre of transom, visible glass area will differ from the Standard range due to differences in the sections
- Single Panel Wide Available (STD) 1 Sash below Transom, or (FXD) All Fixed Panels
- 2 Panel Wide Available (STD) 1 Sash below Transom Left, (REV) 1 Sash below Transom Right, (DS) Double Sash below Transom, or (FXD) All Fixed Panels
- 3 Panel Wide Available (STD) Equal Panels with Sash Bottom Left and Sash Bottom Right, (TS) Equal Panels with 3 Sashes below Transom, (FXD) All Fixed Panels
- 4 Panel Wide Available (STD) Equal Panels with Sash Bottom Left and Sash Bottom Right, or (FXD) All Fixed Panels
- 53mm Wideline Sash frame thickness as standard
- **Double Glazing option for all available sizes above**

Boutique Fixed No Mullion Awning Windows

Single Glazed

Code Prefix: WAAW Suite: BTP, FNM

Size Code		03	04	06	09	12	15	18	21	24	27	30	32	36	40	42	48
	O/A Reveal Size (mm)	330	450	610	850	1210	1450	1810	2170	2410	2710	3010	3250	3610	4000	4210	4810
05	514																
09	854																
10	1027																
12	1200																
14	1372																
15	1543																
18	1800																
20	2057																
21	2110																
23	2315																
24	2370																
27	2700																
30	3000																
40	4000																

 Not Available

Boutique Fixed No Mullion Awning Windows

Double Glazed

Code Prefix: WAAW Suite: BTP, FNM

Size Code		03	04	06	09	12	15	18	21	24	27	30	32	36	40	42	48
	O/A Reveal Size (mm)	330	450	610	850	1210	1450	1810	2170	2410	2710	3010	3250	3610	4000	4210	4810
05	514																
09	854																
10	1027																
12	1200																
14	1372																
15	1543																
18	1800																
20	2057																
21	2110																
23	2315																
24	2370																
27	2700																
30	3000																
40	4000																

- Available with any Glass Combination up to 18mm overall

 Not Available

Boutique Fixed One Mullion Awning Windows

Single Glazed

Code Prefix: WAAW Suite: BTP, 1FM

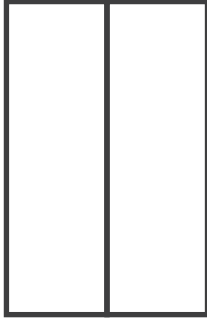
Size Code		06	09	12	15	18	21	24	27	30	32	36	40	42	48	60
	O/A Reveal Size (mm)	610	850	1210	1450	1810	2170	2410	2710	3010	3250	3610	4000	4210	4810	6000
05	514															
09	854															
10	1027															
12	1200															
14	1372															
15	1543															
18	1800															
20	2057															
21	2110															
23	2315															
24	2370															
27	2700															
30	3000															
40	4000															

 Not Available

Boutique Fixed One Mullion Awning Windows

Double Glazed

Code Prefix: WAAW Suite: BTP, 1FM

Size Code		06	09	12	15	18	21	24	27	30	32	36	40	42	48	60
	O/A Reveal Size (mm)	610	850	1210	1450	1810	2170	2410	2710	3010	3250	3610	4000	4210	4810	6000
05	514															
09	854															
10	1027															
12	1200															
14	1372															
15	1543															
18	1800															
20	2057															
21	2110															
23	2315															
24	2370															
27	2700															
30	3000															
40	4000															

- Available with any Glass Combination up to 18mm overall

 Not Available

Boutique Fixed Two Mullion Awning Windows

Single Glazed

Code Prefix: WAAW Suite: BTP, 2FM

Size Code		12	15	18	21	24	27	30	32	36	40	42	48	52	60
	O/A Reveal Size (mm)	1210	1450	1810	2170	2410	2710	3010	3250	3610	4000	4210	4810	5290	6000
05	514														
09	854														
10	1027														
12	1200														
14	1372														
15	1543														
18	1800														
20	2057														
21	2110														
23	2315														
24	2370														
27	2700														
30	3000														
40	4000														

 Not Available

Boutique Fixed Two Mullion Awning Windows

Double Glazed

Code Prefix: WAAW Suite: BTP, 2FM

Size Code		15	18	21	24	27	30	32	36	40	48	60
	O/A Reveal Size (mm)	1450	1810	2170	2410	2710	3010	3250	3610	4000	4810	6000
05	514											
09	854											
10	1027											
12	1200											
14	1372											
15	1543											
18	1800											
20	2057											
21	2110											
23	2315											
24	2370											
27	2700											
30	3000											
40	4000											

- Available with any Glass Combination up to 18mm overall

Not Available

Boutique Fixed Three Mullion Awning Windows

Single Glazed

Code Prefix: WAAW Suite: BTP, 3FM

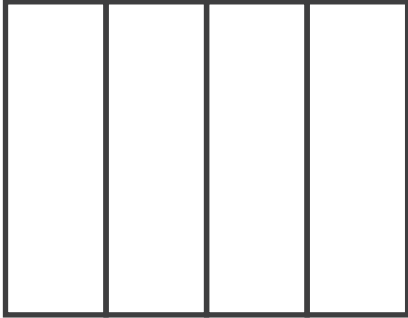
Size Code		15	18	21	24	27	30	32	36	40	42	48	52	60
	O/A Reveal Size (mm)	1450	1810	2170	2410	2710	3010	3250	3610	4000	4250	4810	5290	6000
05	514													
09	854													
10	1027													
12	1200													
14	1372													
15	1543													
18	1800													
20	2057													
21	2110													
23	2315													
24	2370													
27	2700													
30	3000													
40	4000													

 Not Available

Boutique Fixed Three Mullion Awning Windows

Double Glazed

Code Prefix: WAAW Suite: BTP, 3FM

Size Code		15	18	21	24	27	30	32	36	40	42	48	60
	O/A Reveal Size (mm)	1450	1810	2170	2410	2710	3010	3250	3610	4000	4210	4810	6000
05	514												
09	854												
10	1027												
12	1200												
14	1372												
15	1543												
18	1800												
20	2057												
21	2110												
23	2315												
24	2370												
27	2700												
30	3000												
40	4000												

- Available with any Glass Combination up to 18mm overall

Not Available

Boutique Heavy Duty Fixed No Mullion Windows

Double Glazed Only, VIC & Sth NSW Only

Code Prefix: WAAW Suite: BHD, FNM – N2

Size Code		12	15	18	21	24	27	30	36	42	48
	O/A Reveal Size (mm)	1210	1450	1810	2170	2410	2710	3010	3610	4210	4811
12	1200										
14	1372										
15	1543										
18	1800										
21	2110										
24	2370										
27	2660										
30	3000										
40	4000										

- Available with 6mm/6mm or 8mm/8mm Glass Combination up to 24mm overall including air gap
- **Available in VIC & Sth NSW Only**

 Not Available

Boutique Heavy Duty Fixed One Mullion Windows

Double Glazed Only, VIC & Sth NSW Only

Code Prefix: WAAW Suite: BHD, 1FM – N2

Size Code		27	30	36	42	48	53	60
	O/A Reveal Size (mm)	2710	3010	3610	4210	4811	5290	6010
14	1372							
15	1543							
18	1800							
21	2110							
24	2370							
27	2660							

- Available with 6mm/6mm or 8mm/8mm Glass Combination up to 24mm overall including air gap
- **Available in VIC & Sth NSW Only**



 Not Available

Standard Louvre Windows

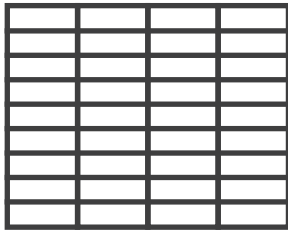
Code Prefix: WALV

Size Code	O/A Reveal Size (mm)	03	06	07	09	12	15	17	18	21	25	24
		330*	610	725	850	1220	1450	1700	1830	2175	2550	2440
05	514											
10	1027											
12	1200											
14	1372											
15	1543											
18	1800											
20	2057											
21	2110											
23	2315											
24	2365											

- 2 Panel Wide Available (STD) Louvre Gallery on Left, (REV) Louvre Gallery on Right, or (DS) Double Louvre Galleries
- 3 Panel Wide Available (STD) Centre Fixed Panel and Louvre Galleries on Left and Right, or (TS) Triple Louvre Galleries
- 4 Panel Wide Available as All Louvre Galleries Only
- Single Glazed Only
- * Toughened glass cannot be used for 330mm wide Louvre blades

-  Not Available
-  Available in QLD & Nth NSW Only

Standard Louvre Windows

Code Prefix: WALV

Size Code		XX	Max Overall Width	XX	Max Overall Width
	O/A Reveal Size (mm)	Variable (Max Louvre Width 850mm)		Variable (Max Louvre Width 850mm)	
10	1027		3610		3610
12	1200		3610		3610
14	1372		3320		3610
15	1543		3020		3610
18	1800		3000		3390
20	2057		3000		3030
23	2315		3000		2920

- Option to choose from either a 610mm, 725mm or 850mm wide Louvre
- 2 Panel Wide (STD) Louvre Gallery on Left and Fixed Panel on Right, (REV) Louvre Gallery on Right and Fixed Panel on Left
- 3 Panel Wide (STD) Fixed Panel in Centre with Louvre Galleries Left and Right
- Single Glazed Only

Standard Double Hung Windows

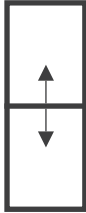
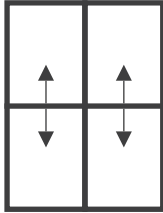
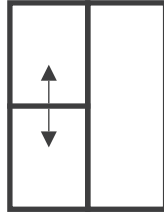
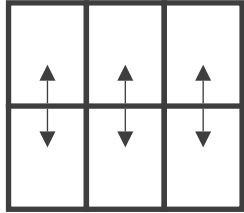

Code Prefix: WADH

Size Code		06	09	12	04	06	07	09	12	15	17	18	27	
	O/A Reveal Size (mm)	610	850	1210	450	610	725	850	1220	1450	1700	1830	2550	
10	1027													
12	1200													
14	1372													
15	1543													
18	1800													
20	2057													
21	2110													

- All Panels Equal Widths
- Single Panel Wide Available (STD) Fixed Only
- 2 Panel Wide Available (DS) Double Hung both sides, (3S) Double Hung on Left and Fixed on Right, or (3R) Double Hung on Right and Fixed on Left
- 3 Panel Wide Available (STD) Triple Double Hungs
- Single Glazed Only
- Double Hung windows can be coupled to Fixed Lights, each Light is made as a separate product then close coupled and revealed as a single product
- Maximum number of products coupled together is 5 items, or maximum overall width of 3610mm
- Maximum overall width varies dependant on product size (check with your Sales Representative for availability)
- **Available in QLD & Nth NSW Only**

Standard Aluminium Door Frame & Window Combinations

Door Frame

Size Code	O/A Reveal Size (mm)		651	751	801	851	901	951	1001	1051	
		Panel (mm)	620	720	770	820	870	920	970	1020	
21	2105	2040									
24	2407	2340									

- Available (STD) Hinged on Left, or (REV) Hinged on Right

 Not Available

Sliding or Awning Window Options

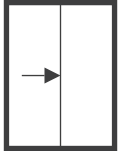
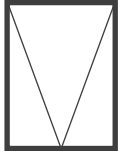
Size Code	O/A Reveal Size (mm)	06	09	12
		610	850	1210
05	514	 		
09	854			
10	1027			
12	1200			

Sliding Window coupled to Aluminium Door Frame

Code Prefix: LAAS

- Single Glazed Only

Awning Window coupled to Aluminium Door Frame

Code Prefix: LAAS

- Single & Double Glazed

- Available (STD) Window on Left, (REV) Window on Right, or (WDB) Window both sides

For Overall Width add window and door width together, for example 610 wide window with 851 wide door frame = 1461 o/a width

Standard Timber Laundry Door Frame & Window Combinations

VIC & Sth NSW Only

Door Frame

Size Code	O/A Reveal Size (mm)	38mm Jamb	665	765	815	865	915	965	1015	1065	1265
		50mm Jamb	691	791	841	891	941	991	1041	1091	1291
		Panel (mm)	620	720	770	820	870	920	970	1020	1200
21	2105 (STD Sill)	2040									
24	2407 (STD Sill)	2340									

- Available (STD) Hinged on Left, or (REV) Hinged on Right, or (NH) No Hinges
- Available with Timber Sill, Alviro Sill or No Sill

Sliding or Awning Window Options

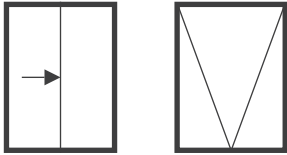
Size Code	O/A Reveal Size (mm)	06	09	12	
05	514		610	850	1210
09	854				
10	1027				
12	1200				

Sliding Window coupled to Timber Door Frame

Code Prefix: LTAS

- Single Glazed Only

Awning Window coupled to Timber Door Frame

Code Prefix: LTAA

- Single & Double Glazed

- Available (STD) Window on Left, (REV) Window on Right, or (WDB) Window both sides

For Overall Width add window and door width together, for example 610 wide window with 865 wide door frame = 1475 o/a width

Overall Height is based on Standard Door Frame with Sill, Height will vary depending on Sill option selected

Standard Shaped Windows

Ellipse Windows

Code Prefix: WAEL05

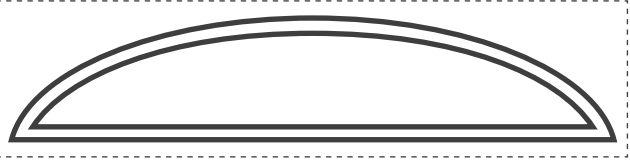
Size Code		12	15	16	17	18
	O/A Reveal (mm)	1278	1518	1753	1778	1878
	O/A Alum (mm)	1210	1450	1685	1710	1810
05	515					

- All Ellipse windows have an Offset reveal set up for Plaster Return
- Elliptical windows can be coupled to Awning or Sliding Windows, each light is made as a separate product then close coupled and revealed as a single product
- Elliptical windows can be coupled to Aluminium or Timber Door Frames, each light is made as a separate product then coupled as a reveal to reveal coupling
- Only available in the above Standard sizes
- Overall reveal size dependent on the product it is coupled to
- Available in Double Glazing

Full Circle Windows

Code Prefix: WAFC

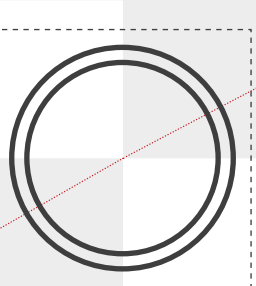
Size Code	06	09
O/A Reveal (mm)	670	970
06	670	
09	970	

- All Full Circle windows come in a square box frame complete with flashing
- All Full Circle windows have an Offset reveal set up for Plaster Return
- Only available in these standard sizes
- Available in Double Glazing
-  Not Available

Standard Shaped Windows

Radius Windows

Code Prefix: WARD

Size Code			06	09	12	15	16	18
	O/A Reveal (mm)		678	918	1278	1518	1749	1878
		O/A Alum	610	850	1210	1450	1681	1810
05	339	305						
05	459	425						
06	639	605						
07	725	725						
09	875	840						
09	939	905						

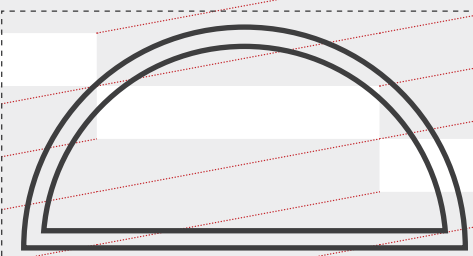

- All Radius windows have an Offset reveal set up for Plaster Return
- Radius windows can be coupled to Awning or Sliding windows, each light is made as a separate product then close coupled and revealed as a single product
- Radius windows can be coupled to Aluminium or Timber Door Frames, each light is made as a separate product then coupled as a reveal to reveal coupling
- Only available in the above Standard sizes
- Overall reveal size dependent on the product it is coupled to
- Double Glazing option for all available sizes above

 Not Available



Standard Aluminium Entries

Aluminium Hinged Doors

Code Prefix: DAHG

Code Prefix: DAHG
+ MS (Mushroom Stop)

+ REB (Rebate)

Size Code (Heightxx)	O/A Reveal Size (mm)		651	751	801	851	901	951	1001	1051	1231	1281	1481	1581	1681	1781	1881	1263	1463	1563	1663	1763	1863	
		Panel (mm)	620	720	770	820	870	920	970	1020	1200	620	720	770	820	870	920	620	720	770	820	870	920	
21	2105	2040																						
24	2405	2340																						







- Available (STD) Hinged on Left, or (REV) Hinged on Right

 Not Available

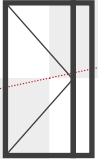
 Available in QLD & Nth NSW Only

Aluminium Door Frames for Corinthian Panels

Code Prefix: EAAS

Size Code			12	14	17	25
	O/A Reveal Size (mm)		1278	1378	1705	2535
21	2105	820				
24	2405	920				





- Available (STD) Sidelight on Left, (REV) Sidelight on Right
- Available (STD) Hinged on Left, (REV) Hinged on Right
- Suits 400mm panel
- Double Glazing option for all available sizes above

 Not Available

Standard Aluminium Entries

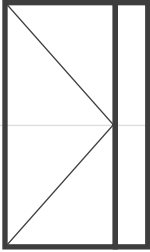
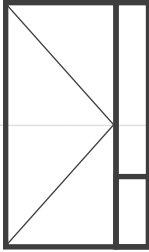
Aluminium Door Frames with Single Sidelights

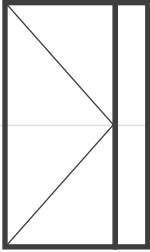
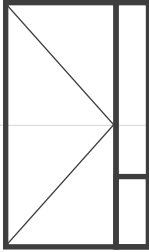
Code Prefix: EAAS

Size Code		10	11	12	13	14	15	18	Width variable with single door & sidelight (XX)	Width variable with double door & sidelight (XX)
	O/A Reveal Size (mm)	1061	1151	1211	1331	1451	1571	1811	2971	2971
21	2105									
24	2405									



- Available (STD) Sidelight on Left, (REV) Sidelight on Right
- Available (STD) Hinged on Left, (REV) Hinged on Right
- Available with or without Transom to Sidelight
- Door Panel Size options Available
- Double glazing option for all available sizes above

Available in VIC & Sth NSW Only

Standard Aluminium Entries

Aluminium Door Frames with Double Sidelights

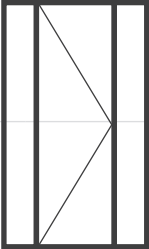
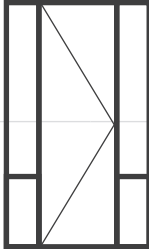
Code Prefix: EAAS

Size Code		12	13	14	15	18	20	Width variable with single door & double sidelight (XX)	Width variable with double door & double sidelight (XX)
	O/A Reveal Size (mm)	1211	1331	1451	1571	1811	2051	2971	2971
21	2105								
24	2405								

- Available (STD) Sidelight on Left, (REV) Sidelight on Right
- Available (STD) Hinged on Left, (REV) Hinged on Right
- Available with up to 4 Transoms or No Transom to Sidelights
- Door Panel Size options Available
- Double glazing option for all available sizes above

Timber Hinged Doors

Code Prefix: DTHG

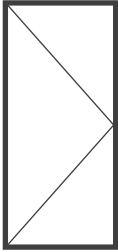
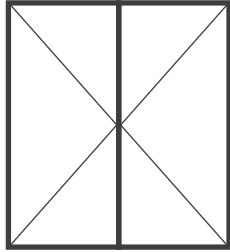
Size Code (Heightxx)	Frame (mm)	38mm Jamb	665	715	765	815	865	915	965	1015	1065	N/A								
		50mm Jamb	691	741	791	841	891	941	991	1041	1091	1271	1321	1421	1521	1621	1721	1821	1921	2121
		Panel (mm)	620	670	720	770	820	870	920	970	1020	1200	620	670	720	770	820	870	920	1020
21	2105 (STD Sill)	2040																		
24	2405 (STD Sill)	2340																		

- Available with Timber Sill, Alviro Sill (50mm Jambs Only), or No Sill
- Available Pre-Hinged or No Hinges
- Hinges Available (STD) Hinged on Left, or (REV) Hinged on Right (single door frames)
- Adjustable door stops on Pre-Hinged doors only
- Double glazing option for all available sizes above
- **Available in VIC & Sth NSW Only**

Timber Door Frames with Timber Single Sidelights

Code Prefix: ETTS

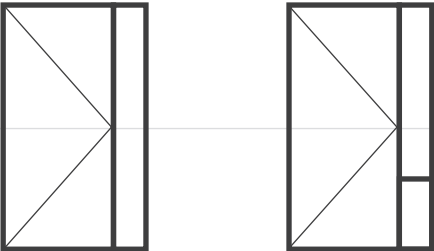
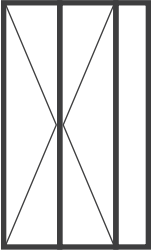
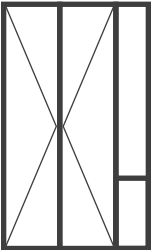



Size Code	10	11	12	13	14	15	16	17	18	Width variable with single door & sidelight (XX)	Width variable with double door & sidelight (XX)
O/A Reveal Size (mm) 38mm Jamb	1090	1145	1211	1330	1450	1570	1650	1745	1810	2971	2400 50mm Jamb
21	2105 (STD Sill)										
											
24	2405 (STD Sill)										

- Available with Timber Sill, Alviro Sill (50mm Jambs Only), or No Sill
- Available Pre-Hinged or No Hinges
- Hinges Available (STD) Hinged on Left, or (REV) Hinged on Right (single door frames)
- Adjustable door stops on Pre-Hinged doors only

- Sidelights Available with up to 4 Transoms
- Door Panel Size options Available
- Double glazing option for all available sizes above
- **Available in VIC & Sth NSW Only**

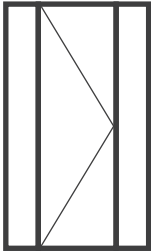
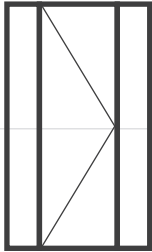
Timber Door Frames with Timber Double Sidelights

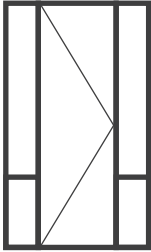
Code Prefix: ETTS

Size Code		Width variable with single door & sidelight (XX)	17 Corinthian Only	Width variable with double door & sidelight (XX)
	O/A Reveal Size (mm) 38mm Jamb	2300	1731 (820 Door Only) 1831 (920 Door Only)	2300 (50mm Jamb)
21	2105 (STD Sill)			
24	2405 (STD Sill)			

- Available with Timber Sill, Alviro Sill (50mm Jambs Only), or No Sill
- Available Pre-Hinged or No Hinges
- Hinges Available (STD) Hinged on Left, or (REV) Hinged on Right (single door frames)
- Adjustable door stops on Pre-Hinged doors only

- Sidelights Available with up to 4 Transoms
- Door Panel Size options Available
- Double glazing option for all available sizes above
- **Available in VIC & Sth NSW Only**

Timber Door Frames with Aluminium Single Sidelights

Code Prefix: ETAS

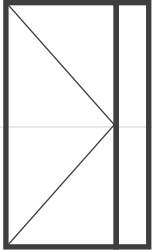
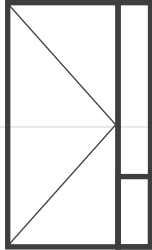

Size Code		10	11	12	13	14	15	18	Width variable with single door & sidelight (XX)	Width variable with double door & sidelight (XX)
O/A Reveal Size (mm) 38mm Jamb		1061	1151	1211	1331	1451	1571	1811	2971	2400 50mm Jamb
21	2105 (STD Sill)									
24	2405 (STD Sill)									

- Available with Timber Sill, Alviro Sill (50mm Jambs Only), or No Sill
- Available Pre-Hinged or No Hinges
- Hinges Available (STD) Hinged on Left, or (REV) Hinged on Right (single door frames)
- Adjustable door stops on Pre-Hinged doors only

- Sidelights Available with up to 4 Transoms
- Door Panel Size options Available
- Double glazing option for all available sizes above
- **Available in VIC & Sth NSW Only**

Timber Door Frames with Aluminium Double Sidelights

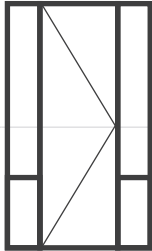
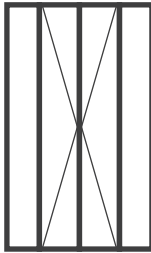
Code Prefix: ETAS

Size Code		12	13	14	15	18	20	Width variable with single door & sidelight (XX)	Width variable with double door & sidelight (XX)
	O/A Reveal Size (mm) 38mm Jamb	1211	1331	1451	1571	1811	2051	2971	2400
21	2105 (STD Sill)								
									
24	2405 (STD Sill)								

- Available with Timber Sill, Alviro Sill (50mm Jambs Only), or No Sill
- Available Pre-Hinged or No Hinges
- Hinges Available (STD) Hinged on Left, or (REV) Hinged on Right (single door frames)
- Adjustable door stops on Pre-Hinged doors only

- Sidelights Available with up to 4 Transoms
- Door Panel Size options Available
- Double glazing option for all available sizes above
- **Available in VIC & Sth NSW Only**

Boutique & Standard Awning Windows

Lineage Collection - Loft Series

Code Prefix: WAAW Colonial Bar Pattern: Loft

Size Code		03	06	09	12	15	18	21	24	27
O/A Reveal Size (mm)		330 (Fixed Only)	610	850	1210	1450	1810	2170	2398	2704
05	514									
09	854									
10	1027									
12	1200									
14	1372									
15	1543									
18	1800									
20	2057									
23	2315									

Please Note: Visible glass area between bars can vary in size across the same product, depending on product type, size and configuration. Speak to your A&L sales representative to find out more.

Please Note: Size charts are provided as a guide only, images may not reflect the exact proportions of the product you specify. Images represent the external view of the product and refer to A&L's standard offering for N2 areas. Specific size limitations or alternative options may be applicable for other wind categories or account customer specific ranges. The A&L website Terms of Use apply to this document. ALNAT0626/0724 July 2024.

Boutique & Standard Armadale Awning Windows

Lineage Collection - Loft Series

Code Prefix: WAAW Colonial Bar Pattern: Loft

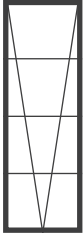
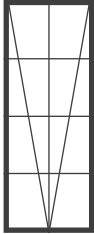
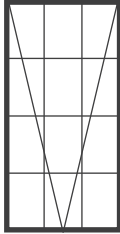
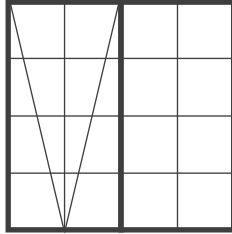
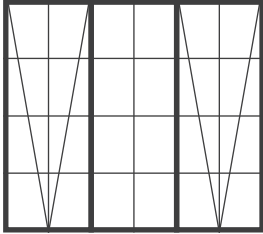







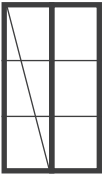
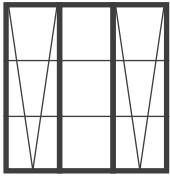
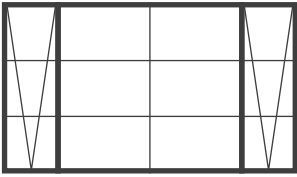

Size Code		03	06	09	12	15	18	21	24	27
	O/A Reveal Size (mm)	330 (Fixed Only)	610	850	1210	1450	1810	2170	2398	2704
18	1800									
20	2057									
23	2315									

Please Note: Visible glass area between bars can vary in size across the same product, depending on product type, size and configuration. Speak to your A&L sales representative to find out more.

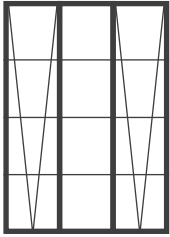
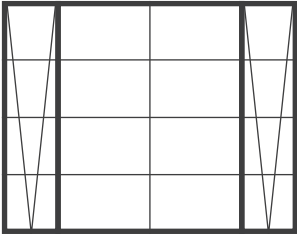
Boutique & Standard Georgian Awning Windows

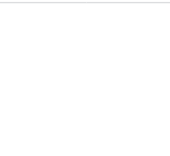
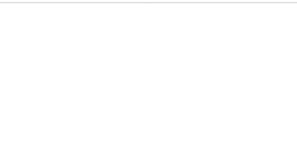
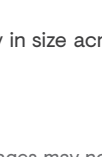
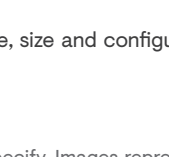
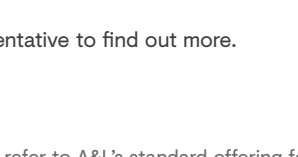
Lineage Collection - Loft Series

Code Prefix: WAAW Colonial Bar Pattern: Loft

Size Code		09	12	15	18	21	24
O/A Reveal Size (mm)		850	1210	1450	1810	2170	2398
10	1027						
12	1200						
14	1372						
15	1543						
18	1800						
20	2057						
23	2315						

Please Note: Visible glass area between bars can vary in size across the same product, depending on product type, size and configuration. Speak to your A&L sales representative to find out more.





Please Note: Size charts are provided as a guide only, images may not reflect the exact proportions of the product you specify. Images represent the external view of the product and refer to A&L's standard offering for N2 areas. Specific size limitations or alternative options may be applicable for other wind categories or account customer specific ranges. The A&L website Terms of Use apply to this document. ALNAT0626/0724 July 2024.

Boutique & Standard Awning Windows

Lineage Collection - Newport Series

Code Prefix: WAAW Colonial Bar Pattern: Newport

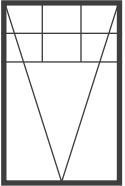
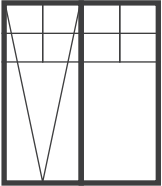
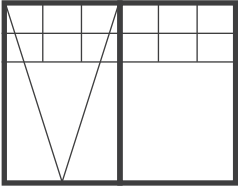
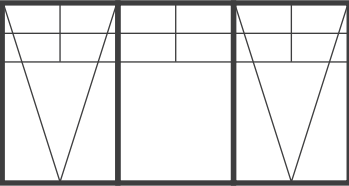
Double

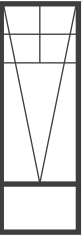
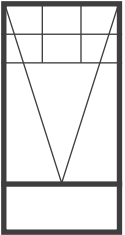
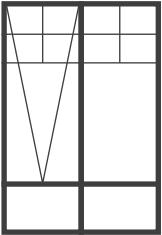
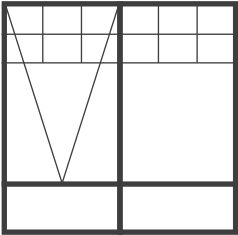
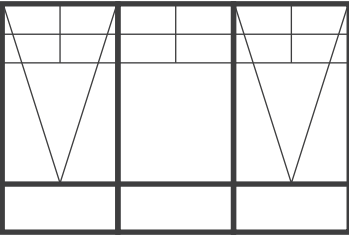
Size Code		03	06	09	12	15	18	21	24	27
O/A Reveal Size (mm)		330 (Fixed Only)	610	850	1210	1450	1810	2170	2398	2704
10	1027									
12	1200									
14	1372									
15	1543									
18	1800									
20	2057									
23	2315									

Please Note: Visible glass area between bars can vary in size across the same product, depending on product type, size and configuration. Speak to your A&L sales representative to find out more.

 Custom size, available upon request

Please Note: Size charts are provided as a guide only, images may not reflect the exact proportions of the product you specify. Images represent the external view of the product and refer to A&L's standard offering for N2 areas. Specific size limitations or alternative options may be applicable for other wind categories or account customer specific ranges. The A&L website Terms of Use apply to this document. ALNAT0626/0724 July 2024.

Boutique & Standard Awning Windows

Lineage Collection - Newport Series

Code Prefix: WAAW Colonial Bar Pattern: Newport

Single

Size Code		03	06	09	12	15	18	21	24	27
O/A Reveal Size (mm)		330 (Fixed Only)	610	850	1210	1450	1810	2170	2398	2704
09	854									
10	1027									
12	1200									
14	1372									
15	1543									
18	1800									
20	2057									
23	2315									

Please Note: Visible glass area between bars can vary in size across the same product, depending on product type, size and configuration. Speak to your A&L sales representative to find out more.

Boutique Armadale Awning Windows

Lineage Collection - Newport Series

Code Prefix: WAAW Colonial Bar Pattern: Newport

Double

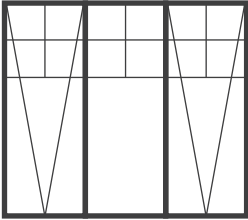
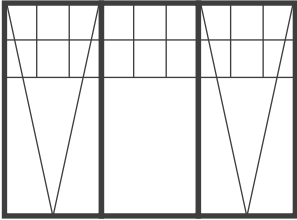
Size Code		18	21	24	27	30	36	
	O/A Reveal Size (mm)	1810	2170	2410	2710	3010	3610	
18	1800							
20	2057							
23	2315							

Single

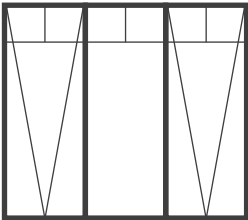
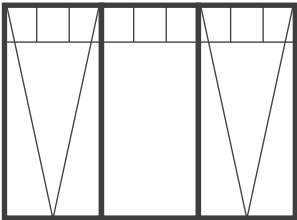
Size Code		18	21	24	27	30	36	
	O/A Reveal Size (mm)	1810	2170	2410	2710	3010	3610	
18	1800							
20	2057							
23	2315							

Please Note: Visible glass area between bars can vary in size across the same product, depending on product type, size and configuration. Speak to your A&L sales representative to find out more.



Please Note: Size charts are provided as a guide only, images may not reflect the exact proportions of the product you specify. Images represent the external view of the product and refer to A&L's standard offering for N2 areas. Specific size limitations or alternative options may be applicable for other wind categories or account customer specific ranges. The A&L website Terms of Use apply to this document. ALNAT0626/0724 July 2024.

Standard Armadale Awning Windows



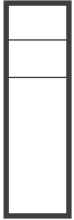
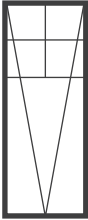
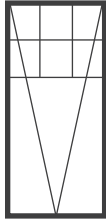
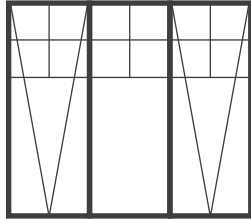
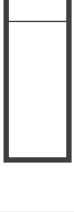
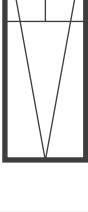
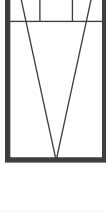
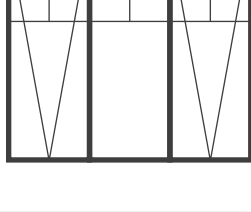

Lineage Collection - Newport Series

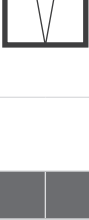
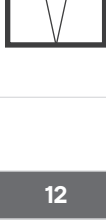
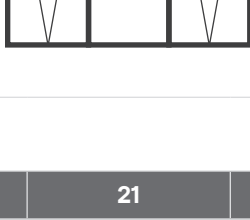
Code Prefix: WAAW Colonial Bar Pattern: Newport

Double

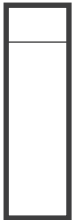
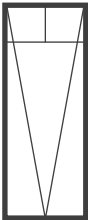
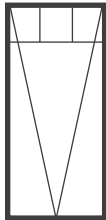
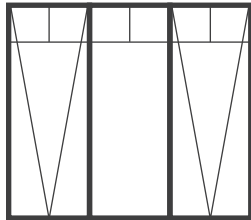
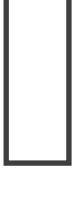
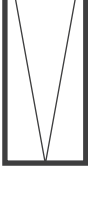
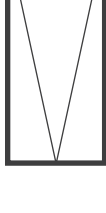
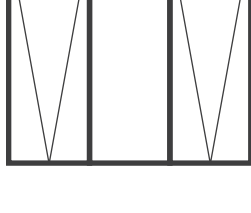
Size Code		03	06	09	12	15	18	21	24	27
	O/A Reveal Size (mm)	330 (Fixed Only)	610	850	1210	1450	1810	2170	2398	2704
18	1800									
20	2057									
23	2315									

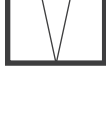
Single

Size Code		03	06	09	12	15	18	21	24	27
	O/A Reveal Size (mm)	330 (Fixed Only)	610	850	1210	1450	1810	2170	2398	2704
18	1800									
20	2057									
23	2315									

Please Note: Visible glass area between bars can vary in size across the same product, depending on product type, size and configuration. Speak to your A&L sales representative to find out more.





Please Note: Size charts are provided as a guide only, images may not reflect the exact proportions of the product you specify. Images represent the external view of the product and refer to A&L's standard offering for N2 areas. Specific size limitations or alternative options may be applicable for other wind categories or account customer specific ranges. The A&L website Terms of Use apply to this document. ALNAT0626/0724 July 2024.

Boutique Georgian Awning Windows



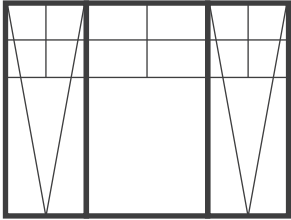
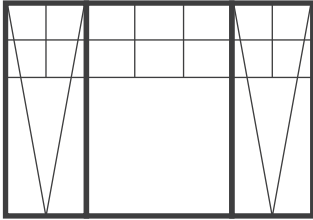
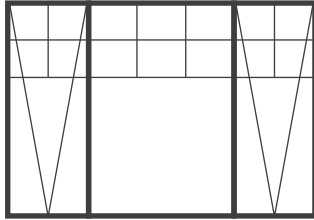
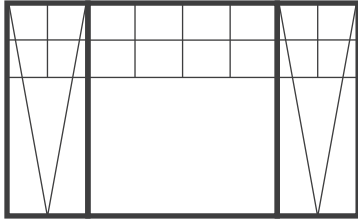
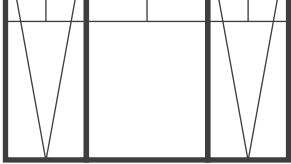
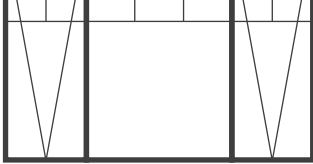
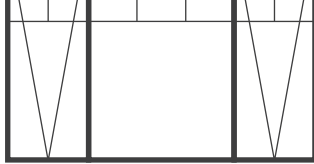
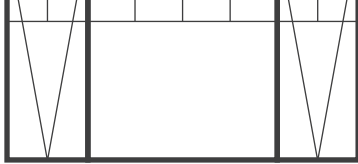



Lineage Collection - Newport Series

Code Prefix: WAAW Colonial Bar Pattern: Newport

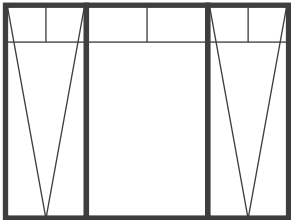
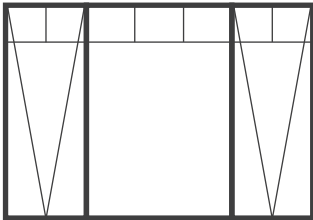
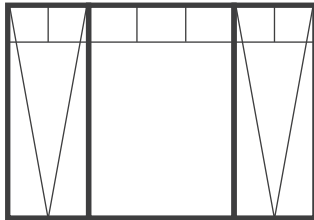
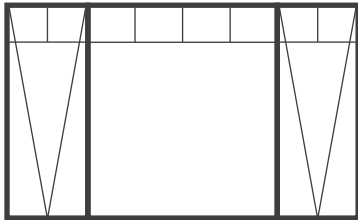
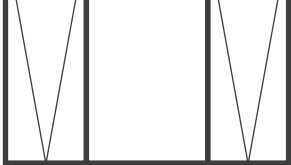
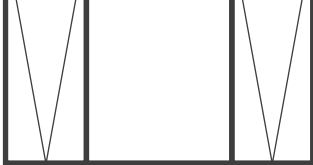
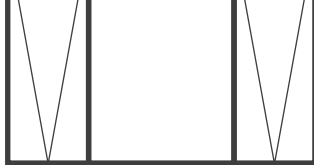
Double

Size Code		18	21	24	27	30	36
	O/A Reveal Size (mm)	1800	2170	2410	2710	3010	3610
18	1800						
20	2057						
23	2315						

Single

Size Code		18	21	24	27	30	36
	O/A Reveal Size (mm)	1800	2170	2410	2710	3010	3610
18	1800						
20	2057						
23	2315						

Please Note: Visible glass area between bars can vary in size across the same product, depending on product type, size and configuration. Speak to your A&L sales representative to find out more.

Please Note: Size charts are provided as a guide only, images may not reflect the exact proportions of the product you specify. Images represent the external view of the product and refer to A&L's standard offering for N2 areas. Specific size limitations or alternative options may be applicable for other wind categories or account customer specific ranges. The A&L website Terms of Use apply to this document. ALNAT0626/0724 July 2024.

Standard Georgian Awning Windows

Lineage Collection - Newport Series

Code Prefix: WAAW Colonial Bar Pattern: Newport

Double

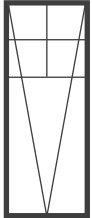
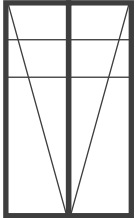
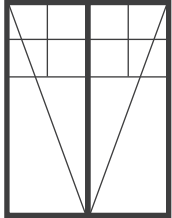
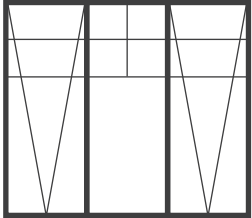
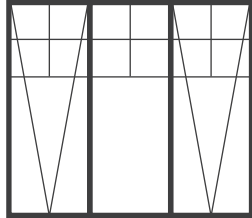
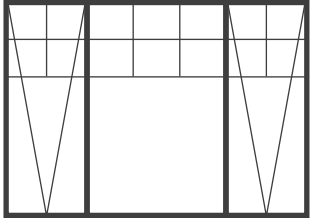
Size Code		06	09	12	15	18	21	24
	O/A Reveal Size (mm)	610	850	1210	1450	1810	2170	2398
10	1027							
12	1200							
14	1372							
15	1543							
18	1800							
20	2057							
23	2315							

Please Note: Visible glass area between bars can vary in size across the same product, depending on product type, size and configuration. Speak to your A&L sales representative to find out more.

 Custom size, available upon request

Please Note: Size charts are provided as a guide only, images may not reflect the exact proportions of the product you specify. Images represent the external view of the product and refer to A&L's standard offering for N2 areas. Specific size limitations or alternative options may be applicable for other wind categories or account customer specific ranges. The A&L website Terms of Use apply to this document. ALNAT0626/0724 July 2024.

Standard Georgian Awning Windows

Lineage Collection - Newport Series

Code Prefix: WAAW Colonial Bar Pattern: Newport

Single

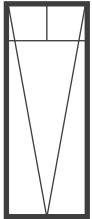
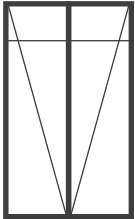
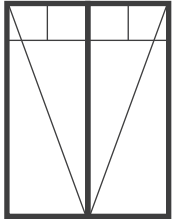
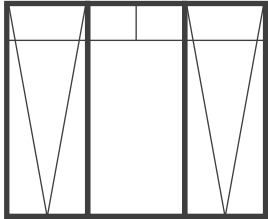
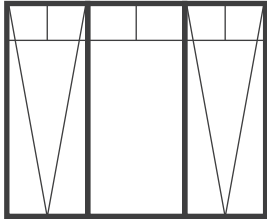
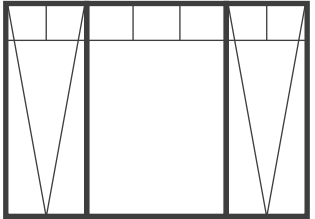
Size Code		06	09	12	15	18	21	24
	O/A Reveal Size (mm)	610	850	1210	1450	1810	2170	2398
09	854							
10	1027							
12	1200							
14	1372							
15	1543							
18	1800							
20	2057							
23	2315							

Please Note: Visible glass area between bars can vary in size across the same product, depending on product type, size and configuration. Speak to your A&L sales representative to find out more.

 Custom size, available upon request

Please Note: Size charts are provided as a guide only, images may not reflect the exact proportions of the product you specify. Images represent the external view of the product and refer to A&L's standard offering for N2 areas. Specific size limitations or alternative options may be applicable for other wind categories or account customer specific ranges. The A&L website Terms of Use apply to this document. ALNAT0626/0724 July 2024.

Boutique & Standard Awning Windows

Lineage Collection - Gatsby Series

Code Prefix: WAAW Colonial Bar Pattern: Gatsby

Size Code		03	06	09	12	15	18	21	24	27
O/A Reveal Size (mm)		330 (Fixed Only)	610	850	1210	1450	1810	2170	2398	2704
05	514									
09	854									
10	1027									
12	1200									
14	1372									
15	1543									
18	1800									
20	2057									
23	2315									









Please Note: Visible glass area between bars can vary in size across the same product, depending on product type, size and configuration. Speak to your A&L sales representative to find out more.

Please Note: Size charts are provided as a guide only, images may not reflect the exact proportions of the product you specify. Images represent the external view of the product and refer to A&L's standard offering for N2 areas. Specific size limitations or alternative options may be applicable for other wind categories or account customer specific ranges. The A&L website Terms of Use apply to this document. ALNAT0626/0724 July 2024.

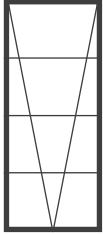
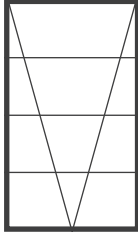
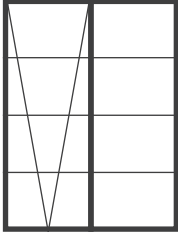
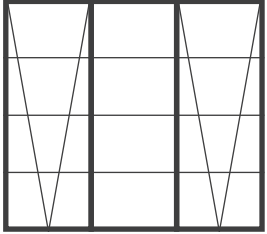
Boutique & Standard Armadale Awning Windows

Lineage Collection - Gatsby Series

Code Prefix: WAAW Colonial Bar Pattern: Gatsby











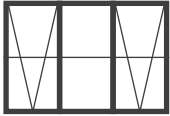



Size Code		03	06	09	12	15	18	21	24	27
	O/A Reveal Size (mm)	330 (Fixed Only)	610	850	1210	1450	1810	2170	2398	2704
18	1800									
20	2057									
23	2315									

Please Note: Visible glass area between bars can vary in size across the same product, depending on product type, size and configuration. Speak to your A&L sales representative to find out more.

Boutique & Standard Georgian Awning Windows

Lineage Collection - Gatsby Series

Code Prefix: WAAW Colonial Bar Pattern: Gatsby

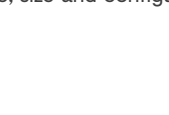
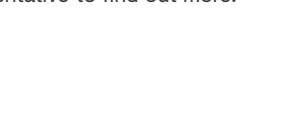
Size Code		09	12	15	18	21	24
O/A Reveal Size (mm)		850	1210	1450	1810	2170	2398
10	1027						
12	1200						
14	1372						
15	1543						
18	1800						
20	2057						
23	2315						

Please Note: Visible glass area between bars can vary in size across the same product, depending on product type, size and configuration. Speak to your A&L sales representative to find out more.

Please Note: Size charts are provided as a guide only, images may not reflect the exact proportions of the product you specify. Images represent the external view of the product and refer to A&L's standard offering for N2 areas. Specific size limitations or alternative options may be applicable for other wind categories or account customer specific ranges. The A&L website Terms of Use apply to this document. ALNAT0626/0724 July 2024.

Boutique Fixed No Mullion Windows

Lineage Collection - Loft Series

Code Prefix: WAAW Colonial Bar Pattern: Loft

Size Code		06	09	12	15	18	21	24	27	30	36
O/A Reveal Size (mm)		610	850	1210	1450	1810	2170	2410	2710	3010	3610
05	514										
09	854										
10	1027										
12	1200										
14	1372										
15	1543										
18	1800										
20	2057										
23	2315										

Please Note: Visible glass area between bars can vary in size across the same product, depending on product type, size and configuration. Speak to your A&L sales representative to find out more.

Boutique Fixed No Mullion Windows

Lineage Collection – Newport Series

Code Prefix: WAAW Colonial Bar Pattern: Newport

Double

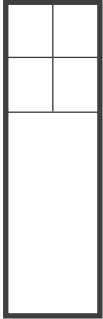
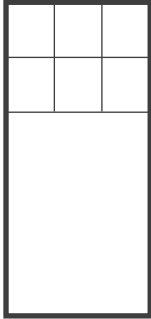
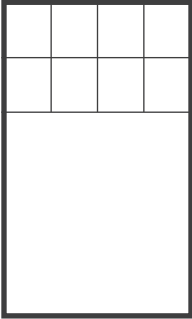
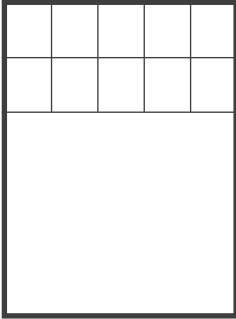
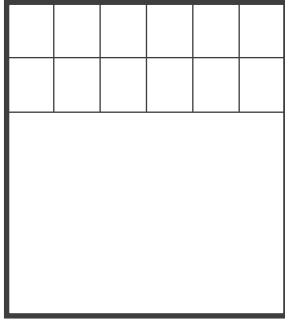
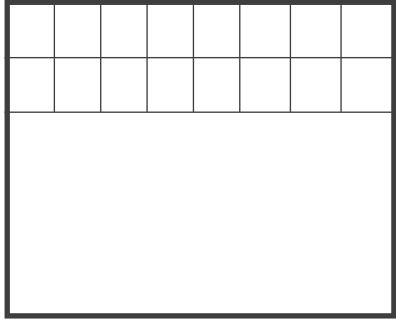
Size Code		06	09	12	15	18	21	24	27	30	36
	O/A Reveal Size (mm)	610	850	1210	1450	1810	2170	2398	2704	3010	3610
10	1027										
12	1200										
14	1372										
15	1543										
18	1800										
20	2057										
23	2315										

Please Note: Visible glass area between bars can vary in size across the same product, depending on product type, size and configuration. Speak to your A&L sales representative to find out more.

 Custom size, available upon request



Please Note: Size charts are provided as a guide only, images may not reflect the exact proportions of the product you specify. Images represent the external view of the product and refer to A&L's standard offering for N2 areas. Specific size limitations or alternative options may be applicable for other wind categories or account customer specific ranges. The A&L website Terms of Use apply to this document. ALNAT0626/0724 July 2024.

Boutique Fixed No Mullion Windows

Lineage Collection – Newport Series

Code Prefix: WAAW Colonial Bar Pattern: Newport

Single

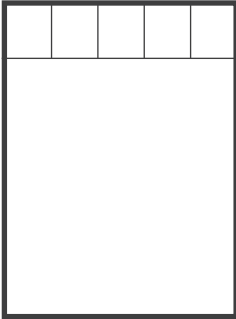
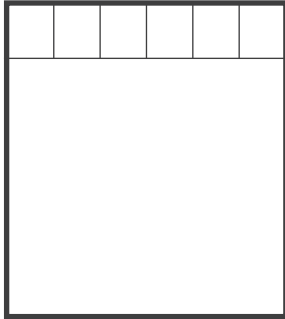
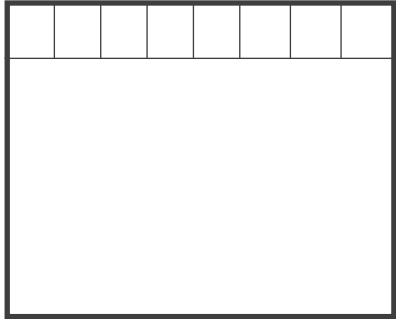
Size Code		06	09	12	15	18	21	24	27	30	36
	O/A Reveal Size (mm)	610	850	1210	1450	1810	2170	2398	2704	3010	3610
09	854										
10	1027										
12	1200										
14	1372										
15	1543										
18	1800										
20	2057										
23	2315										

Please Note: Visible glass area between bars can vary in size across the same product, depending on product type, size and configuration. Speak to your A&L sales representative to find out more.

 Custom size, available upon request

Please Note: Size charts are provided as a guide only, images may not reflect the exact proportions of the product you specify. Images represent the external view of the product and refer to A&L's standard offering for N2 areas. Specific size limitations or alternative options may be applicable for other wind categories or account customer specific ranges. The A&L website Terms of Use apply to this document. ALNAT0626/0724 July 2024.

Boutique Fixed No Mullion Windows

Lineage Collection – Gatsby Series

Code Prefix: WAAW Colonial Bar Pattern: Gatsby







Size Code		06	09	12	15	18	21	24	27	30	36
	O/A Reveal Size (mm)	610	850	1210	1450	1810	2170	2410	2710	3010	3610
05	514										
09	854										
10	1027										
12	1200										
14	1372										
15	1543										
18	1800										
20	2057										
23	2315										

Please Note: Visible glass area between bars can vary in size across the same product, depending on product type, size and configuration. Speak to your A&L sales representative to find out more.

Boutique Fixed One Mullion Windows

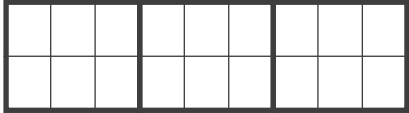
Lineage Collection - Loft Series

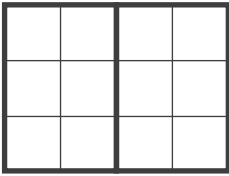
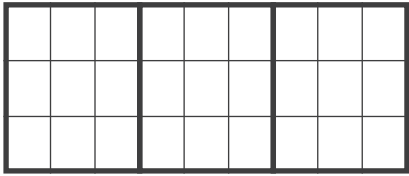
Code Prefix: WAAW Colonial Bar Pattern: Loft

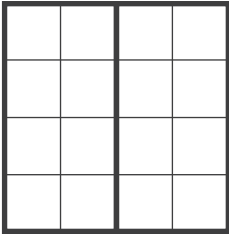
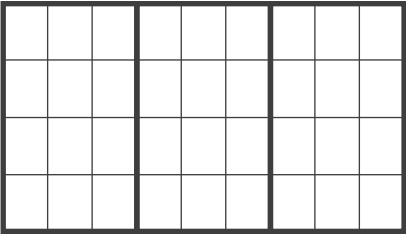
Size Code		06	09	12	15	18	21	24	27	30	36
O/A Reveal Size (mm)		610	850	1210	1450	1810	2170	2410	2710	3010	3610
05	514										
09	854										
10	1027										
12	1200										
14	1372										
15	1543										
18	1800										
20	2057										
23	2315										

Please Note: Visible glass area between bars can vary in size across the same product, depending on product type, size and configuration. We recommend sashes in lieu of any fixed lites for the most consistent aesthetic. Speak to your A&L sales representative to find out more.

Please Note: Size charts are provided as a guide only, images may not reflect the exact proportions of the product you specify. Images represent the external view of the product and refer to A&L's standard offering for N2 areas. Specific size limitations or alternative options may be applicable for other wind categories or account customer specific ranges. The A&L website Terms of Use apply to this document. ALNAT0626/0724 July 2024.

Boutique Fixed One Mullion Windows

Lineage Collection – Newport Series

Code Prefix: WAAW Colonial Bar Pattern: Newport

Double

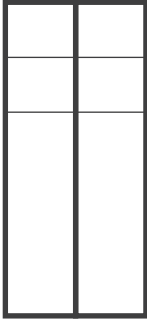
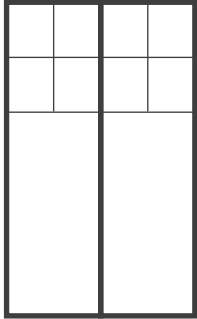
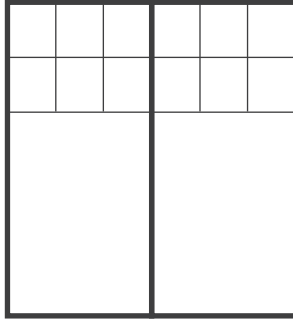
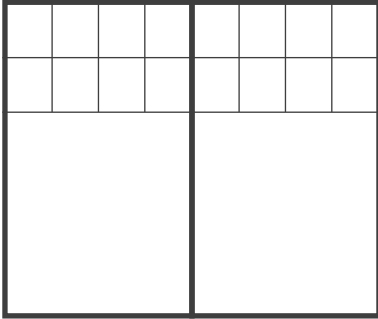
Size Code		06	09	12	15	18	21	24	27	30	36	
	O/A Reveal Size (mm)	610	850	1210	1450	1810	2170	2398	2704	3010	3610	
10	1027											
12	1200											
14	1372											
15	1543											
18	1800											
20	2057											
23	2315											

Please Note: Visible glass area between bars can vary in size across the same product, depending on product type, size and configuration. We recommend sashes in lieu of any fixed lites for the most consistent aesthetic. Speak to your A&L sales representative to find out more.

 Custom size, available upon request

Please Note: Size charts are provided as a guide only, images may not reflect the exact proportions of the product you specify. Images represent the external view of the product and refer to A&L's standard offering for N2 areas. Specific size limitations or alternative options may be applicable for other wind categories or account customer specific ranges. The A&L website Terms of Use apply to this document. ALNAT0626/0724 July 2024.

Boutique Fixed One Mullion Windows

Lineage Collection – Newport Series

Code Prefix: WAAW Colonial Bar Pattern: Newport

Single

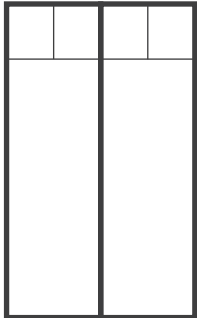
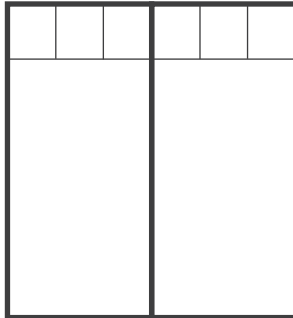
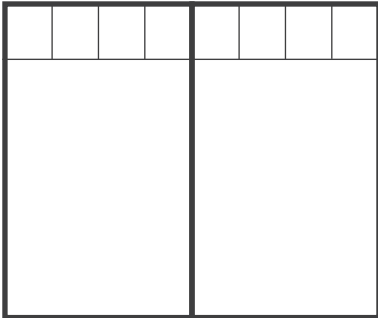
Size Code		06	09	12	15	18	21	24	27	30	36
	O/A Reveal Size (mm)	610	850	1210	1450	1810	2170	2398	2704	3010	3610
09	854										
10	1027										
12	1200										
14	1372										
15	1543										
18	1800										
20	2057										
23	2315										

Please Note: Visible glass area between bars can vary in size across the same product, depending on product type, size and configuration. We recommend sashes in lieu of any fixed lites for the most consistent aesthetic. Speak to your A&L sales representative to find out more.



 Custom size, available upon request

Please Note: Size charts are provided as a guide only, images may not reflect the exact proportions of the product you specify. Images represent the external view of the product and refer to A&L's standard offering for N2 areas. Specific size limitations or alternative options may be applicable for other wind categories or account customer specific ranges. The A&L website Terms of Use apply to this document. ALNAT0626/0724 July 2024.

Boutique Fixed One Mullion Windows

Lineage Collection - Gatsby Series

Code Prefix: WAAW Colonial Bar Pattern: Gatsby

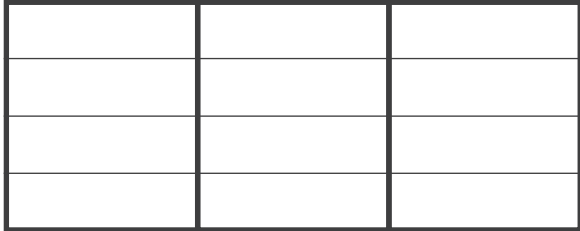
Size Code		06	09	12	15	18	21	24	27	30	36
	O/A Reveal Size (mm)	610	850	1210	1450	1810	2170	2410	2710	3010	3610
05	514										
09	854										
10	1027										
12	1200										
14	1372										
15	1543										
18	1800										
20	2057										
23	2315										



Please Note: Visible glass area between bars can vary in size across the same product, depending on product type, size and configuration. We recommend sashes in lieu of any fixed lites for the most consistent aesthetic. Speak to your A&L sales representative to find out more.

Please Note: Size charts are provided as a guide only, images may not reflect the exact proportions of the product you specify. Images represent the external view of the product and refer to A&L's standard offering for N2 areas. Specific size limitations or alternative options may be applicable for other wind categories or account customer specific ranges. The A&L website Terms of Use apply to this document. ALNAT0626/0724 July 2024.

Boutique Fixed Two Mullion Windows

Lineage Collection - Loft Series

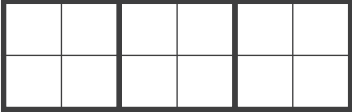
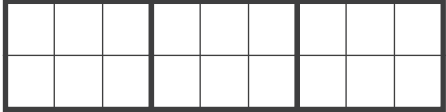
Code Prefix: WAAW Colonial Bar Pattern: Loft

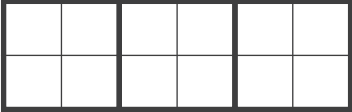
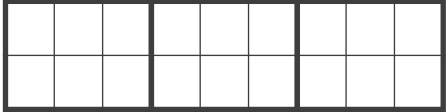
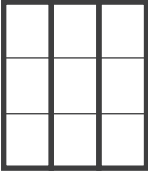
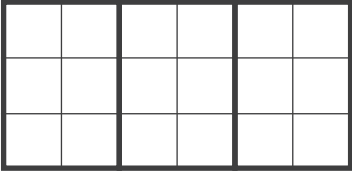
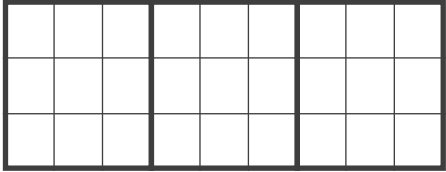
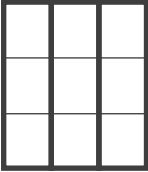
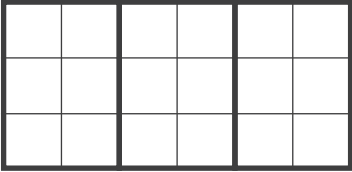
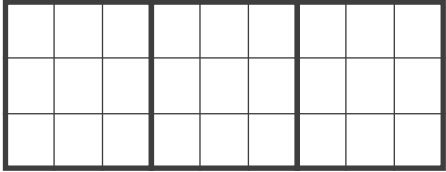
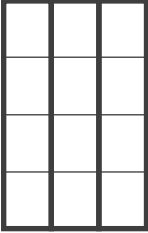
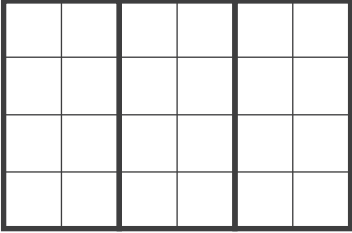
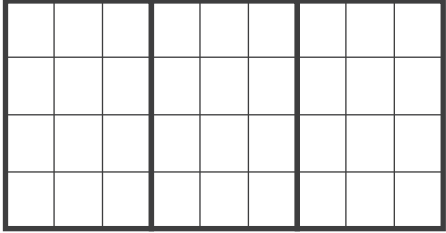
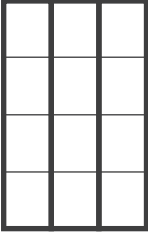
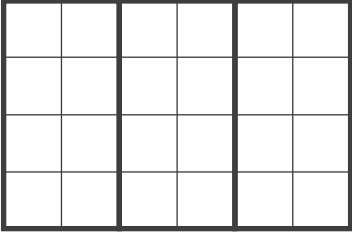
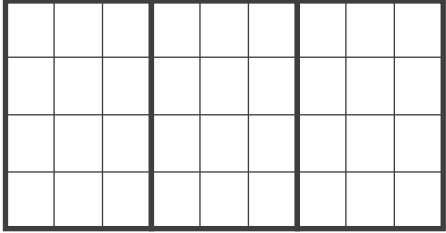
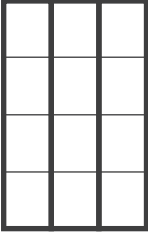
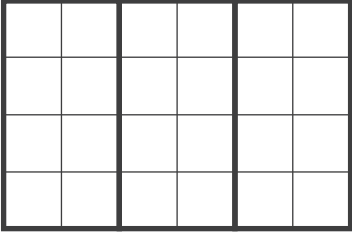
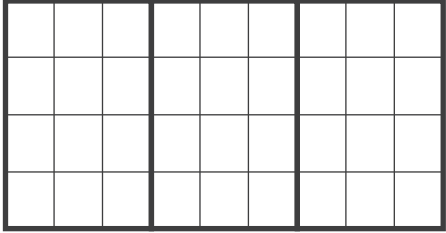
Size Code		12	15	18	21	24	27	30	36
O/A Reveal Size (mm)		1210	1450	1810	2170	2410	2710	3010	3610
05	514								
09	854								
10	1027								
12	1200								
14	1372								
15	1543								
18	1800								
20	2057								
23	2315								

Please Note: Visible glass area between bars can vary in size across the same product, depending on product type, size and configuration. We recommend sashes in lieu of any fixed lites for the most consistent aesthetic. Speak to your A&L sales representative to find out more.

Please Note: Size charts are provided as a guide only, images may not reflect the exact proportions of the product you specify. Images represent the external view of the product and refer to A&L's standard offering for N2 areas. Specific size limitations or alternative options may be applicable for other wind categories or account customer specific ranges. The A&L website Terms of Use apply to this document. ALNAT0626/0724 July 2024.

Boutique Fixed Two Mullion Windows

Lineage Collection – Newport Series

Code Prefix: WAAW Colonial Bar Pattern: Newport

Double

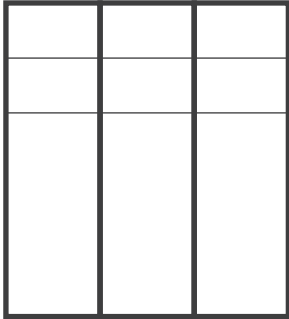
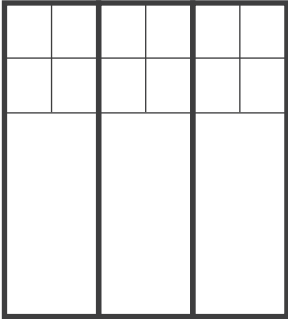
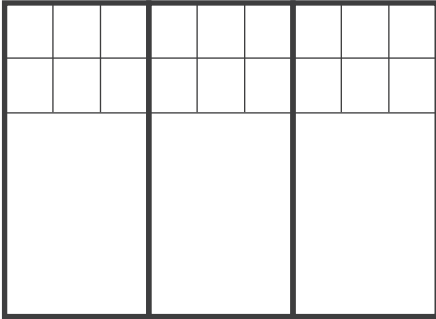
Size Code		12	15	18	21	24	27	30	36	
	O/A Reveal Size (mm)	1210	1450	1810	2170	2398	2704	3010	3610	
10	1027									
12	1200									
14	1372									
15	1543									
18	1800									
20	2057									
23	2315									

Please Note: Visible glass area between bars can vary in size across the same product, depending on product type, size and configuration. We recommend sashes in lieu of any fixed lites for the most consistent aesthetic. Speak to your A&L sales representative to find out more.

 Custom size, available upon request

Please Note: Size charts are provided as a guide only, images may not reflect the exact proportions of the product you specify. Images represent the external view of the product and refer to A&L's standard offering for N2 areas. Specific size limitations or alternative options may be applicable for other wind categories or account customer specific ranges. The A&L website Terms of Use apply to this document. ALNAT0626/0724 July 2024.

Boutique Fixed Two Mullion Windows

Lineage Collection – Newport Series

Code Prefix: WAAW Colonial Bar Pattern: Newport

Single

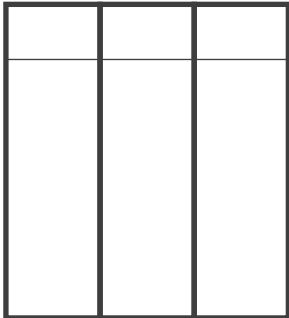
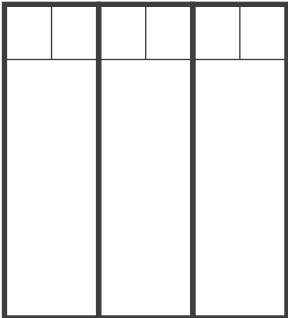
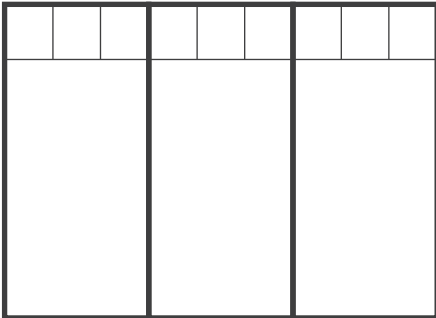
Size Code		12	15	18	21	24	27	30	36	
	O/A Reveal Size (mm)	1210	1450	1810	2170	2398	2704	3010	3610	
09	854									
10	1027									
12	1200									
14	1372									
15	1543									
18	1800									
20	2057									
23	2315									

Please Note: Visible glass area between bars can vary in size across the same product, depending on product type, size and configuration. We recommend sashes in lieu of any fixed lites for the most consistent aesthetic. Speak to your A&L sales representative to find out more.







 Custom size, available upon request

Please Note: Size charts are provided as a guide only, images may not reflect the exact proportions of the product you specify. Images represent the external view of the product and refer to A&L's standard offering for N2 areas. Specific size limitations or alternative options may be applicable for other wind categories or account customer specific ranges. The A&L website Terms of Use apply to this document. ALNAT0626/0724 July 2024.

Boutique Fixed Two Mullion Windows

Lineage Collection - Gatsby Series

Code Prefix: WAAW Colonial Bar Pattern: Gatsby

Size Code		12	15	18	21	24	27	30	36
	O/A Reveal Size (mm)	1210	1450	1810	2170	2410	2710	3010	3610
05	514								
09	854								
10	1027								
12	1200								
14	1372								
15	1543								
18	1800								
20	2057								
23	2315								

Please Note: Visible glass area between bars can vary in size across the same product, depending on product type, size and configuration. We recommend sashes in lieu of any fixed lites for the most consistent aesthetic. Speak to your A&L sales representative to find out more.

Please Note: Size charts are provided as a guide only, images may not reflect the exact proportions of the product you specify. Images represent the external view of the product and refer to A&L's standard offering for N2 areas. Specific size limitations or alternative options may be applicable for other wind categories or account customer specific ranges. The A&L website Terms of Use apply to this document. ALNAT0626/0724 July 2024.

Boutique Fixed Three Mullion Windows

Lineage Collection - Loft Series

Code Prefix: WAAW Colonial Bar Pattern: Loft

Size Code		18	21	24	27	30	36	
O/A Reveal Size (mm)		1810	2170	2410	2710	3010	3610	
05	514							
09	854							
10	1027							
12	1200							
14	1372							
15	1543							
18	1800							
20	2057							
23	2315							

Please Note: Visible glass area between bars can vary in size across the same product, depending on product type, size and configuration. We recommend sashes in lieu of any fixed lites for the most consistent aesthetic. Speak to your A&L sales representative to find out more.

Please Note: Size charts are provided as a guide only, images may not reflect the exact proportions of the product you specify. Images represent the external view of the product and refer to A&L's standard offering for N2 areas. Specific size limitations or alternative options may be applicable for other wind categories or account customer specific ranges. The A&L website Terms of Use apply to this document. ALNAT0626/0724 July 2024.

Boutique Fixed Three Mullion Windows

Lineage Collection – Newport Series

Code Prefix: WAAW Colonial Bar Pattern: Newport

Double

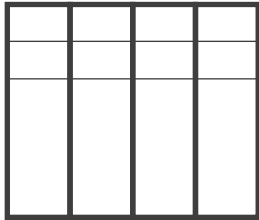
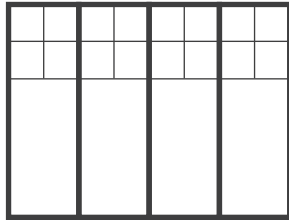
Size Code		18	21	24	27	30	36
	O/A Reveal Size (mm)	1810	2170	2398	2704	3010	3610
10	1027						
12	1200						
14	1372						
15	1543						
18	1800						
20	2057						
23	2315						

Please Note: Visible glass area between bars can vary in size across the same product, depending on product type, size and configuration. We recommend sashes in lieu of any fixed lites for the most consistent aesthetic. Speak to your A&L sales representative to find out more.

 Custom size, available upon request

Please Note: Size charts are provided as a guide only, images may not reflect the exact proportions of the product you specify. Images represent the external view of the product and refer to A&L's standard offering for N2 areas. Specific size limitations or alternative options may be applicable for other wind categories or account customer specific ranges. The A&L website Terms of Use apply to this document. ALNAT0626/0724 July 2024.

Boutique Fixed Three Mullion Windows

Lineage Collection – Newport Series

Code Prefix: WAAW Colonial Bar Pattern: Newport

Single

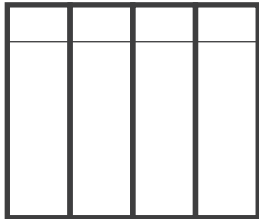
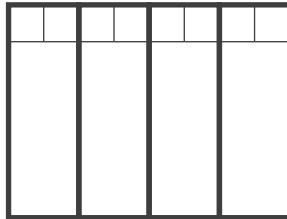
Size Code		18	21	24	27	30	36
	O/A Reveal Size (mm)	1810	2170	2398	2704	3010	3610
09	854						
10	1027						
12	1200						
14	1372						
15	1543						
18	1800						
20	2057						
23	2315						

Please Note: Visible glass area between bars can vary in size across the same product, depending on product type, size and configuration. We recommend sashes in lieu of any fixed lites for the most consistent aesthetic. Speak to your A&L sales representative to find out more.

 Custom size, available upon request

Please Note: Size charts are provided as a guide only, images may not reflect the exact proportions of the product you specify. Images represent the external view of the product and refer to A&L's standard offering for N2 areas. Specific size limitations or alternative options may be applicable for other wind categories or account customer specific ranges. The A&L website Terms of Use apply to this document. ALNAT0626/0724 July 2024.

Boutique Fixed Three Mullion Windows

Lineage Collection – Gatsby Series

Code Prefix: WAAW Colonial Bar Pattern: Gatsby

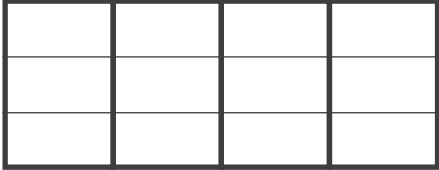
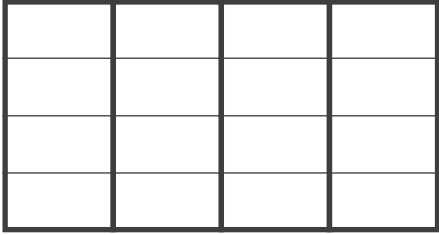
Size Code		12	15	18	21	24	27	30	36
	O/A Reveal Size (mm)	1210	1450	1810	2170	2410	2710	3010	3610
05	514								
09	854								
10	1027								
12	1200								
14	1372								
15	1543								
18	1800								
20	2057								
23	2315								

Please Note: Visible glass area between bars can vary in size across the same product, depending on product type, size and configuration. We recommend sashes in lieu of any fixed lites for the most consistent aesthetic. Speak to your A&L sales representative to find out more.

Please Note: Size charts are provided as a guide only, images may not reflect the exact proportions of the product you specify. Images represent the external view of the product and refer to A&L's standard offering for N2 areas. Specific size limitations or alternative options may be applicable for other wind categories or account customer specific ranges. The A&L website Terms of Use apply to this document. ALNAT0626/0724 July 2024.

Sliding Windows

Lineage Collection - Loft Series

Code Prefix: WASL Colonial Bar Pattern: Loft

Size Code		03	06	09	12	15	18	21	24	27
	O/A Reveal Size (mm)	330 (Fixed Only)	610	850	1210	1450	1810	2170	2398	2704
05	514									
09	854									
10	1027									
12	1200									
14	1372									
15	1543									
18	1800									
20	2057									
23	2315									

Please Note: Visible glass area between bars can vary in size across the same product, depending on product type, size and configuration. We recommend sashes in lieu of any fixed lites for the most consistent aesthetic. Speak to your A&L sales representative to find out more.

Please Note: Size charts are provided as a guide only, images may not reflect the exact proportions of the product you specify. Images represent the external view of the product and refer to A&L's standard offering for N2 areas. Specific size limitations or alternative options may be applicable for other wind categories or account customer specific ranges. The A&L website Terms of Use apply to this document. ALNAT0626/0724 July 2024.

Sliding Windows

Lineage Collection - Newport Series

Code Prefix: WASL Colonial Bar Pattern: Newport

Double

Size Code		03	06	09	12	15	18	21	24	27
O/A Reveal Size (mm)		330 (Fixed Only)	610	850	1210	1450	1810	2170	2398	2704
10	1027									
12	1200									
14	1372									
15	1543									
18	1800									
20	2057									
23	2315									

Please Note: Visible glass area between bars can vary in size across the same product, depending on product type, size and configuration. We recommend sashes in lieu of any fixed lites for the most consistent aesthetic. Speak to your A&L sales representative to find out more.

 Custom size, available upon request

Please Note: Size charts are provided as a guide only, images may not reflect the exact proportions of the product you specify. Images represent the external view of the product and refer to A&L's standard offering for N2 areas. Specific size limitations or alternative options may be applicable for other wind categories or account customer specific ranges. The A&L website Terms of Use apply to this document. ALNAT0626/0724 July 2024.

Sliding Windows

Lineage Collection - Newport Series

Code Prefix: WASL Colonial Bar Pattern: Newport

Single

Size Code		03	06	09	12	15	18	21	24	27
O/A Reveal Size (mm)		330 (Fixed Only)	610	850	1210	1450	1810	2170	2398	2704
09	854									
10	1027									
12	1200									
14	1372									
15	1543									
18	1800									
20	2057									
23	2315									

Please Note: Visible glass area between bars can vary in size across the same product, depending on product type, size and configuration. We recommend sashes in lieu of any fixed lites for the most consistent aesthetic. Speak to your A&L sales representative to find out more.







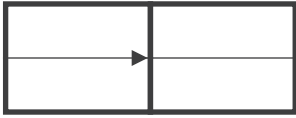

 Custom size, available upon request

Please Note: Size charts are provided as a guide only, images may not reflect the exact proportions of the product you specify. Images represent the external view of the product and refer to A&L's standard offering for N2 areas. Specific size limitations or alternative options may be applicable for other wind categories or account customer specific ranges. The A&L website Terms of Use apply to this document. ALNAT0626/0724 July 2024.

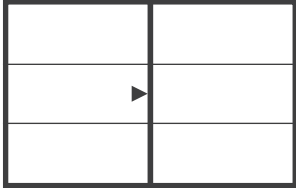
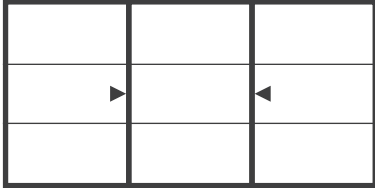
Sliding Windows

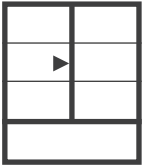
Lineage Collection - Gatsby Series

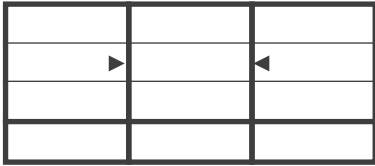
Code Prefix: WASL Colonial Bar Pattern: Gatsby

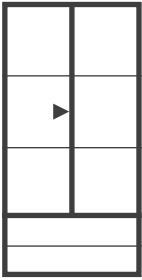
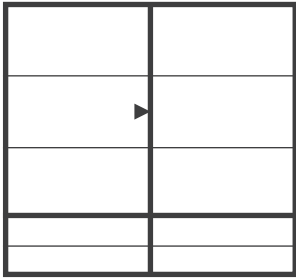
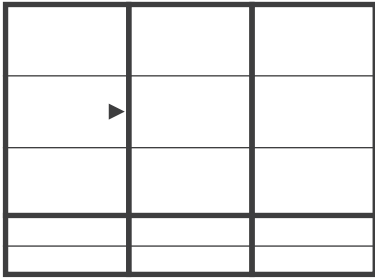
Size Code		03	06	09	12	15	18	21	24	27
O/A Reveal Size (mm)		330 (Fixed Only)	610	850	1210	1450	1810	2170	2398	2704
05	514									
09	854									
10	1027									
12	1200									
14	1372									
15	1543									
18	1800									
20	2057									
23	2315									

Please Note: Visible glass area between bars can vary in size across the same product, depending on product type, size and configuration. We recommend sashes in lieu of any fixed lites for the most consistent aesthetic. Speak to your A&L sales representative to find out more.

Please Note: Size charts are provided as a guide only, images may not reflect the exact proportions of the product you specify. Images represent the external view of the product and refer to A&L's standard offering for N2 areas. Specific size limitations or alternative options may be applicable for other wind categories or account customer specific ranges. The A&L website Terms of Use apply to this document. ALNAT0626/0724 July 2024.

Standard Sliding Doors

Lineage Collection - Loft Series

Code Prefix: DASL Colonial Bar Pattern: Loft

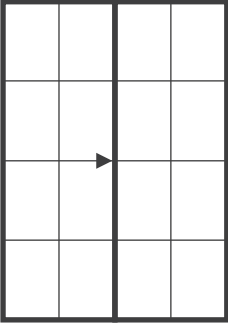
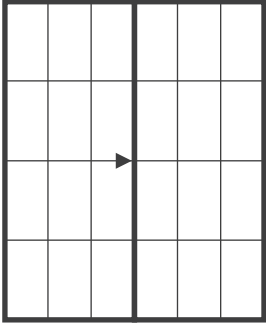
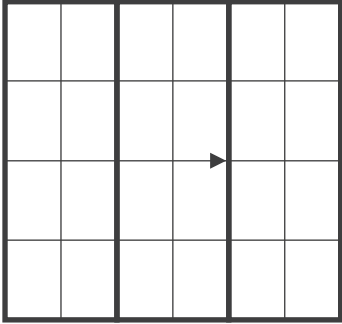
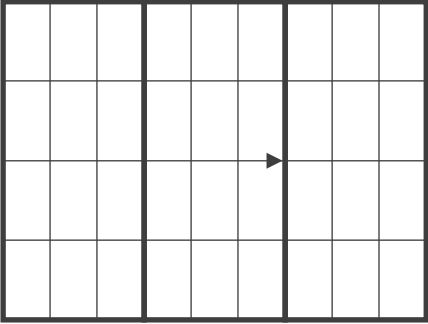
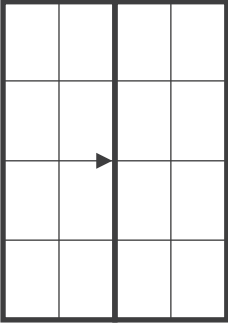
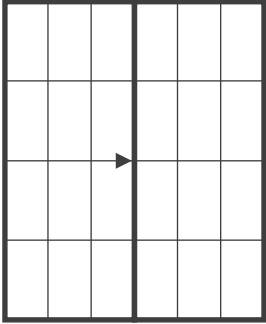
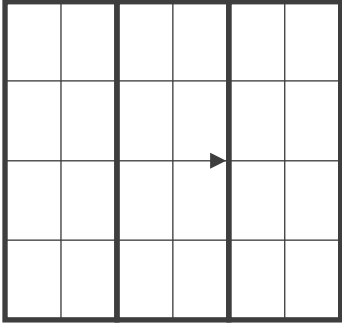
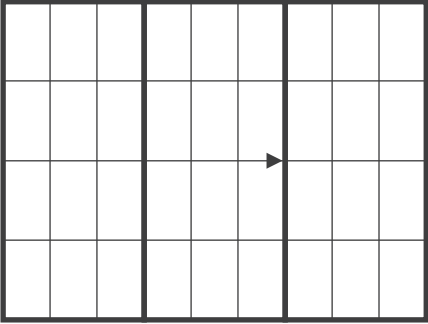
Size Code		14	18	21	24	27	32	36
	O/A Reveal Size (mm)	1450	1810	2170	2410	2690	3230	3590
21	2110							
23	2370							

Please Note: Visible glass area between bars can vary in size across the same product, depending on product type, size and configuration. Speak to your A&L sales representative to find out more.

Standard Sliding Doors

Lineage Collection - Loft Series

Code Prefix: DASL Colonial Bar Pattern: Loft

Bi-Parting

Size Code		28	36	42	48
	O/A Reveal Size (mm)	2855	3575	4295	4775
21	2110				
23	2370				

Entertainer

Size Code		21	27	32	36	42
	O/A Reveal Size (mm)	2133	2673	3231	3573	4217
21	2110					
23	2370					

Please Note: Visible glass area between bars can vary in size across the same product, depending on product type, size and configuration. Speak to your A&L sales representative to find out more.

Please Note: Size charts are provided as a guide only, images may not reflect the exact proportions of the product you specify. Images represent the external view of the product and refer to A&L's standard offering for N2 areas. Specific size limitations or alternative options may be applicable for other wind categories or account customer specific ranges. The A&L website Terms of Use apply to this document. ALNAT0626/0724 July 2024.

Standard Sliding Doors

Lineage Collection – Newport Series

Code Prefix: DASL Colonial Bar Pattern: Newport

Double

Size Code		14	18	21	24	27	30	32	36
	O/A Reveal Size (mm)	1450	1810	2170	2410	2690	3010	3230	3590
21	2110								
23	2370								

Single

Size Code		14	18	21	24	27	30	32	36
	O/A Reveal Size (mm)	1450	1810	2170	2410	2690	3010	3230	3590
21	2110								
23	2370								

Please Note: Visible glass area between bars can vary in size across the same product, depending on product type, size and configuration. Speak to your A&L sales representative to find out more.

Please Note: Size charts are provided as a guide only, images may not reflect the exact proportions of the product you specify. Images represent the external view of the product and refer to A&L's standard offering for N2 areas. Specific size limitations or alternative options may be applicable for other wind categories or account customer specific ranges. The A&L website Terms of Use apply to this document. ALNAT0626/0724 July 2024.

Standard Sliding Doors

Lineage Collection – Newport Series

Code Prefix: DASL Colonial Bar Pattern: Newport

Bi-Parting Double

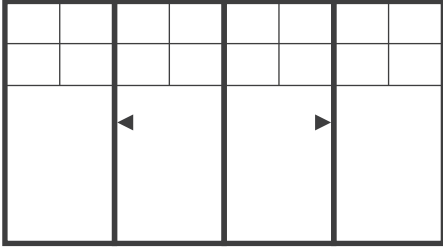
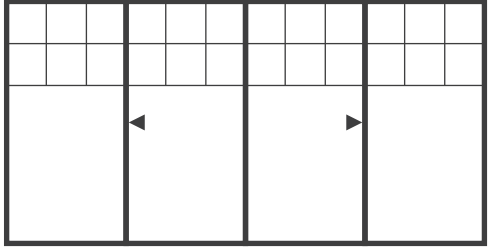
Size Code		28	36	42	48
	O/A Reveal Size (mm)	2855	3590	4295	4775
21	2110				
23	2370				

Bi-Parting Single

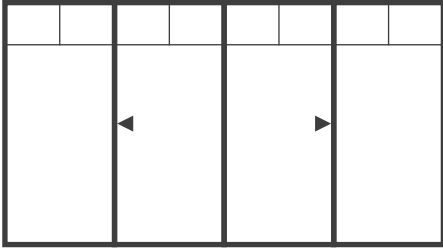
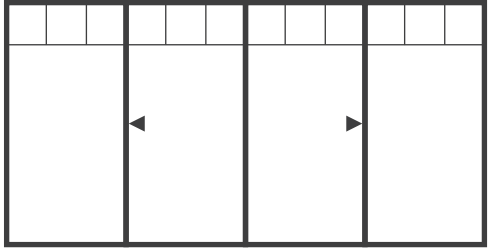
Size Code		28	36	42	48
	O/A Reveal Size (mm)	2855	3590	4295	4775
21	2110				
23	2370				

Please Note: Visible glass area between bars can vary in size across the same product, depending on product type, size and configuration. Speak to your A&L sales representative to find out more.

Please Note: Size charts are provided as a guide only, images may not reflect the exact proportions of the product you specify. Images represent the external view of the product and refer to A&L's standard offering for N2 areas. Specific size limitations or alternative options may be applicable for other wind categories or account customer specific ranges. The A&L website Terms of Use apply to this document. ALNAT0626/0724 July 2024.

Standard Sliding Doors

Lineage Collection – Newport Series

Code Prefix: DASL Colonial Bar Pattern: Newport

Entertainer Double

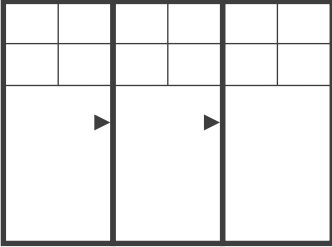
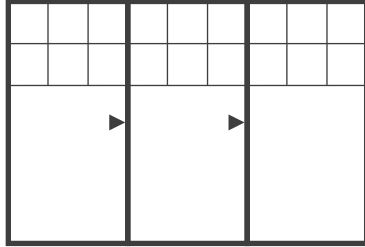
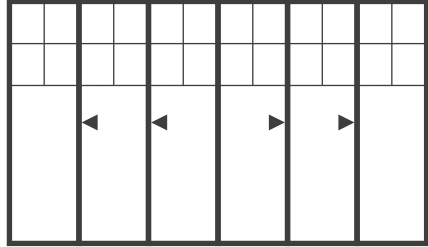
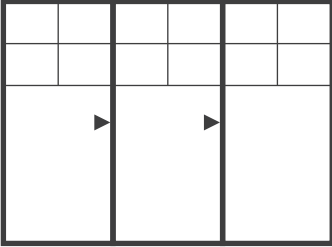
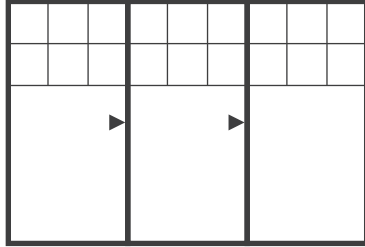
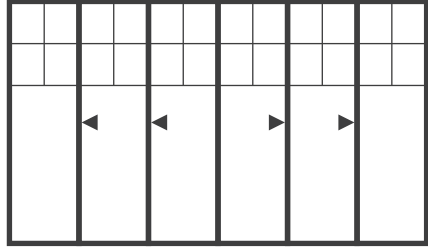
Size Code		21	27	32	36	42
	O/A Reveal Size (mm)	2133	2673	3231	3573	4217
21	2110					
23	2370					

Entertainer Single

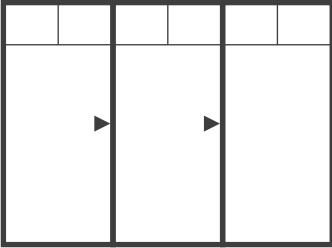
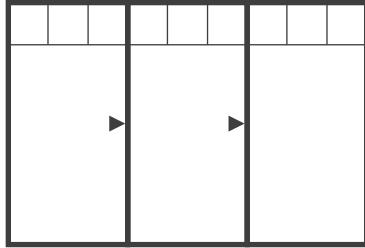
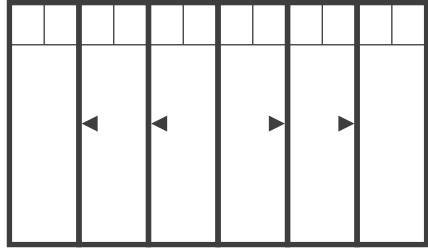
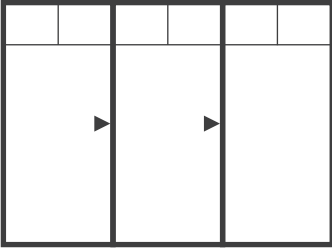
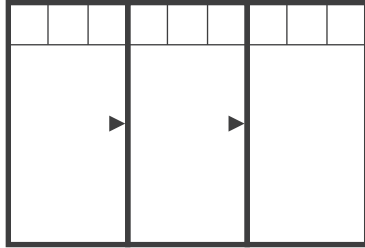
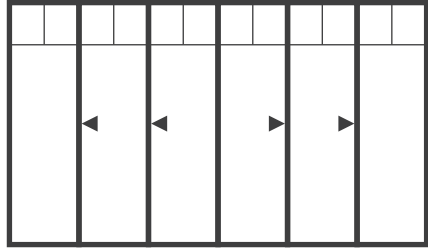
Size Code		21	27	32	36	42
	O/A Reveal Size (mm)	2133	2673	3231	3573	4217
21	2110					
23	2370					

Please Note: Visible glass area between bars can vary in size across the same product, depending on product type, size and configuration. Speak to your A&L sales representative to find out more.

Please Note: Size charts are provided as a guide only, images may not reflect the exact proportions of the product you specify. Images represent the external view of the product and refer to A&L's standard offering for N2 areas. Specific size limitations or alternative options may be applicable for other wind categories or account customer specific ranges. The A&L website Terms of Use apply to this document. ALNAT0626/0724 July 2024.

Standard Sliding Doors

Lineage Collection – Gatsby Series

Code Prefix: DASL Colonial Bar Pattern: Gatsby

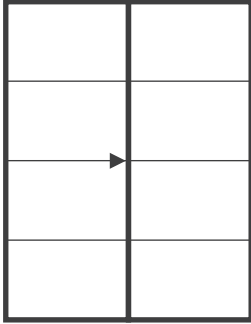
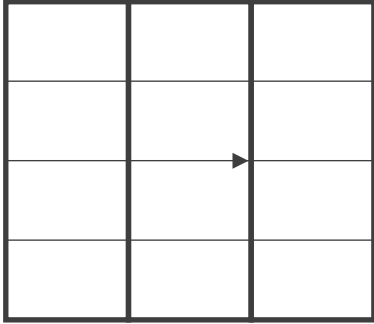
Size Code		14	18	21	24	27	32	36
	O/A Reveal Size (mm)	1450	1810	2170	2410	2690	3230	3590
21	2110							
23	2370							

Please Note: Visible glass area between bars can vary in size across the same product, depending on product type, size and configuration. Speak to your A&L sales representative to find out more.

Standard Sliding Doors

Lineage Collection – Gatsby Series

Code Prefix: DASL Colonial Bar Pattern: Gatsby

Bi-Parting

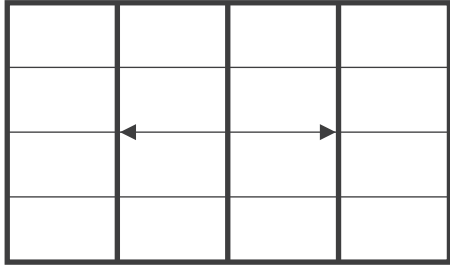
Size Code		28	36	42	48
	O/A Reveal Size (mm)	2855	3575	4295	4775
21	2110				
23	2370				

Entertainer

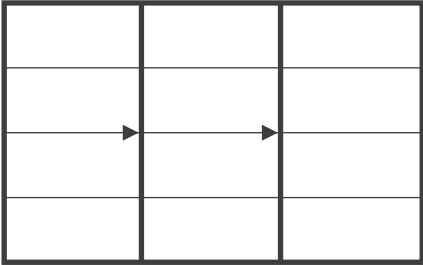
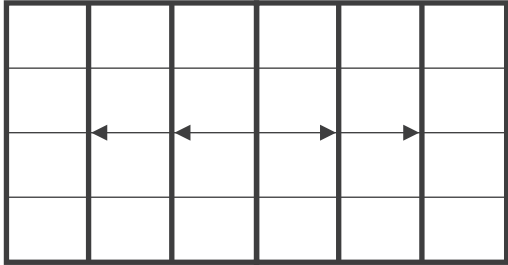
Size Code		21	27	32	36	42	
	O/A Reveal Size (mm)	2133	2673	3231	3573	4217	
21	2110						
23	2370						

Please Note: Visible glass area between bars can vary in size across the same product, depending on product type, size and configuration. Speak to your A&L sales representative to find out more.

Please Note: Size charts are provided as a guide only, images may not reflect the exact proportions of the product you specify. Images represent the external view of the product and refer to A&L's standard offering for N2 areas. Specific size limitations or alternative options may be applicable for other wind categories or account customer specific ranges. The A&L website Terms of Use apply to this document. ALNAT0626/0724 July 2024.

Boutique Sliding Doors

Lineage Collection – Loft Series

Code Prefix: DASL Colonial Bar Pattern: Loft

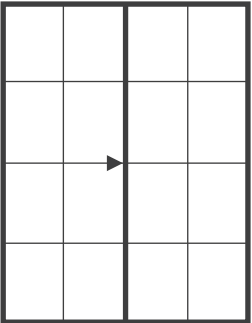
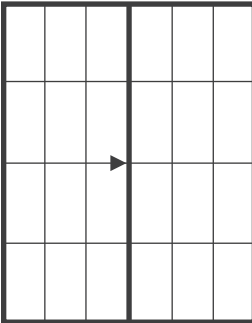
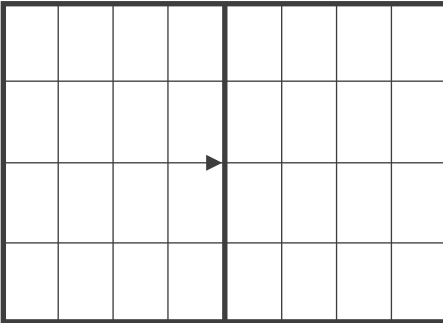
Size Code		14	18	21	24	27	30	32	36	
	O/A Reveal Size (mm)	1450	1810	2170	2410	2710	3010	3250	3610	
21	2110									
23	2370									
26	2660									

Please Note: Visible glass area between bars can vary in size across the same product, depending on product type, size and configuration. Speak to your A&L sales representative to find out more.

Please Note: Size charts are provided as a guide only, images may not reflect the exact proportions of the product you specify. Images represent the external view of the product and refer to A&L's standard offering for N2 areas. Specific size limitations or alternative options may be applicable for other wind categories or account customer specific ranges. The A&L website Terms of Use apply to this document. ALNAT0626/0724 July 2024.

Boutique Sliding Doors

Lineage Collection – Loft Series

Code Prefix: DASL Colonial Bar Pattern: Loft

Bi-Parting

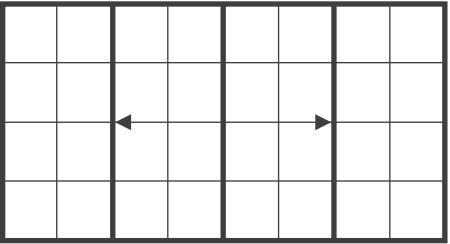
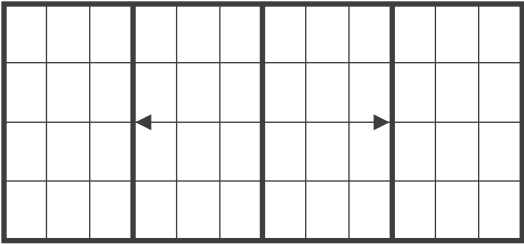
Size Code		28	36	42	48	53	59	
	O/A Reveal Size (mm)	2824	3544	4264	4744	5344	5944	
21	2110							
23	2370							
26	2660							

Please Note: Visible glass area between bars can vary in size across the same product, depending on product type, size and configuration. Speak to your A&L sales representative to find out more.

Please Note: Size charts are provided as a guide only, images may not reflect the exact proportions of the product you specify. Images represent the external view of the product and refer to A&L's standard offering for N2 areas. Specific size limitations or alternative options may be applicable for other wind categories or account customer specific ranges. The A&L website Terms of Use apply to this document. ALNAT0626/0724 July 2024.

Boutique Sliding Doors

Lineage Collection – Loft Series

Code Prefix: DASL Colonial Bar Pattern: Loft

Entertainer

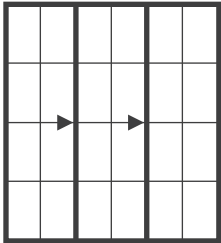
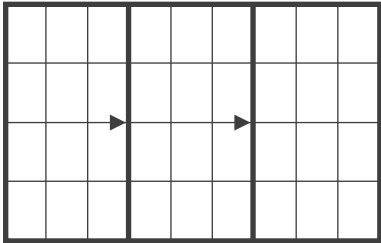
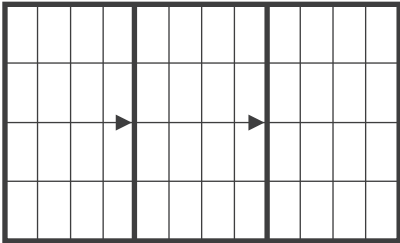
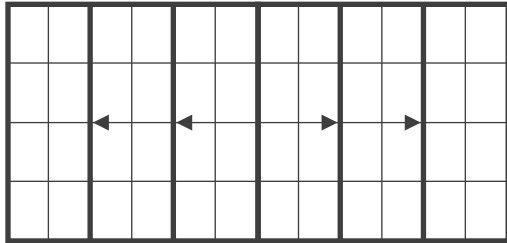
Size Code		21	27	30	32	36	40	45	48	54	42	53	64
O/A Reveal Size (mm)		2133	2673	2994	3213	3573	4023	4473	4833	5373	4188	5268	6368
21	2110												
23	2370												
26	2660												

Please Note: Visible glass area between bars can vary in size across the same product, depending on product type, size and configuration. Speak to your A&L sales representative to find out more.

Please Note: Size charts are provided as a guide only, images may not reflect the exact proportions of the product you specify. Images represent the external view of the product and refer to A&L's standard offering for N2 areas. Specific size limitations or alternative options may be applicable for other wind categories or account customer specific ranges. The A&L website Terms of Use apply to this document. ALNAT0626/0724 July 2024.

Boutique Sliding Doors

Lineage Collection – Newport Series

Code Prefix: DASL Colonial Bar Pattern: Newport

Double

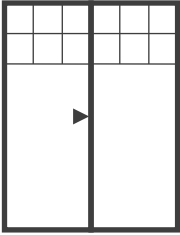
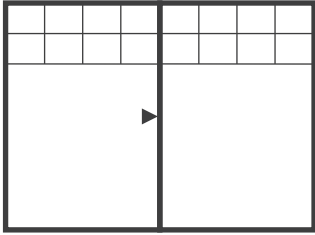
Size Code		14	18	21	24	27	30	32	36	
	O/A Reveal Size (mm)	1450	1810	2170	2410	2690	3010	3230	3590	
21	2110									
23	2370									
26	2660									

Single

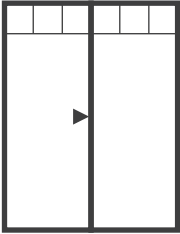
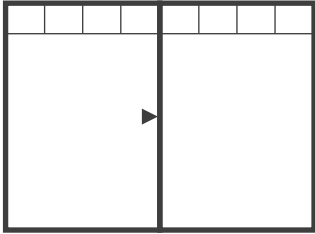
Size Code		14	18	21	24	27	30	32	36	
	O/A Reveal Size (mm)	1450	1810	2170	2410	2690	3010	3230	3590	
21	2110									
23	2370									
26	2660									

Please Note: Visible glass area between bars can vary in size across the same product, depending on product type, size and configuration. Speak to your A&L sales representative to find out more.

Please Note: Size charts are provided as a guide only, images may not reflect the exact proportions of the product you specify. Images represent the external view of the product and refer to A&L's standard offering for N2 areas. Specific size limitations or alternative options may be applicable for other wind categories or account customer specific ranges. The A&L website Terms of Use apply to this document. ALNAT0626/0724 July 2024.

Boutique Sliding Doors

Lineage Collection – Newport Series

Code Prefix: DASL Colonial Bar Pattern: Newport

Bi-Parting Double

Size Code		28	36	42	48	53	59
	O/A Reveal Size (mm)	2824	3544	4264	4744	5344	5944
21	2110						
23	2370						
26	2660						

Bi-Parting Single

Size Code		28	36	42	48	53	59
	O/A Reveal Size (mm)	2824	3544	4264	4744	5344	5944
21	2110						
23	2370						
26	2660						

Please Note: Visible glass area between bars can vary in size across the same product, depending on product type, size and configuration. Speak to your A&L sales representative to find out more.

Please Note: Size charts are provided as a guide only, images may not reflect the exact proportions of the product you specify. Images represent the external view of the product and refer to A&L's standard offering for N2 areas. Specific size limitations or alternative options may be applicable for other wind categories or account customer specific ranges. The A&L website Terms of Use apply to this document. ALNAT0626/0724 July 2024.

Boutique Sliding Doors

Lineage Collection – Newport Series

Code Prefix: DASL Colonial Bar Pattern: Newport

Entertainer Double

Size Code		21	27	30	32	36	48	54	42	53	64		
	O/A Reveal Size (mm)	2133	2673	2994	3213	3573	4833	5373	4188	5268	6368		
21	2110												
23	2370												
26	2660												

Entertainer Single

Size Code		21	27	30	32	36	48	54	42	53	64		
	O/A Reveal Size (mm)	2133	2673	2994	3213	3573	4833	5373	4188	5268	6368		
21	2110												
23	2370												
26	2660												

Please Note: Visible glass area between bars can vary in size across the same product, depending on product type, size and configuration. Speak to your A&L sales representative to find out more.

Please Note: Size charts are provided as a guide only, images may not reflect the exact proportions of the product you specify. Images represent the external view of the product and refer to A&L's standard offering for N2 areas. Specific size limitations or alternative options may be applicable for other wind categories or account customer specific ranges. The A&L website Terms of Use apply to this document. ALNAT0626/0724 July 2024.

Boutique Sliding Doors

Lineage Collection – Gatsby Series

Code Prefix: DASL Colonial Bar Pattern: Gatsby

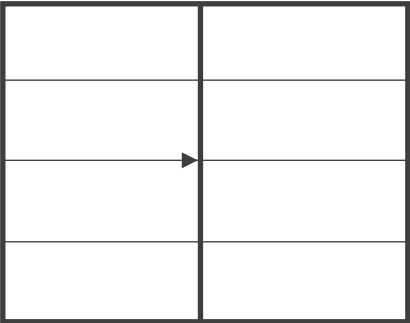
Size Code		14	18	21	24	27	32	36
	O/A Reveal Size (mm)	1450	1810	2170	2410	2690	3230	3590
21	2110							
23	2370							
26	2660							

Please Note: Visible glass area between bars can vary in size across the same product, depending on product type, size and configuration. Speak to your A&L sales representative to find out more.

Please Note: Size charts are provided as a guide only, images may not reflect the exact proportions of the product you specify. Images represent the external view of the product and refer to A&L's standard offering for N2 areas. Specific size limitations or alternative options may be applicable for other wind categories or account customer specific ranges. The A&L website Terms of Use apply to this document. ALNAT0626/0724 July 2024.

Boutique Sliding Doors

Lineage Collection – Gatsby Series

Code Prefix: DASL Colonial Bar Pattern: Gatsby

Bi-Parting

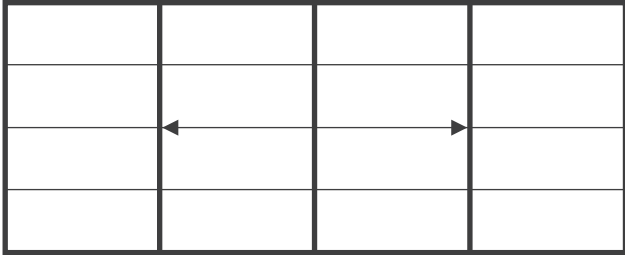
Size Code		28	36	42	48	53	59
	O/A Reveal Size (mm)	2824	3544	4264	4744	5344	5944
21	2110						
23	2370						
26	2660						

Please Note: Visible glass area between bars can vary in size across the same product, depending on product type, size and configuration. Speak to your A&L sales representative to find out more.

Please Note: Size charts are provided as a guide only, images may not reflect the exact proportions of the product you specify. Images represent the external view of the product and refer to A&L's standard offering for N2 areas. Specific size limitations or alternative options may be applicable for other wind categories or account customer specific ranges. The A&L website Terms of Use apply to this document. ALNAT0626/0724 July 2024.

Boutique Sliding Doors

Lineage Collection – Gatsby Series

Code Prefix: DASL Colonial Bar Pattern: Gatsby

Entertainer

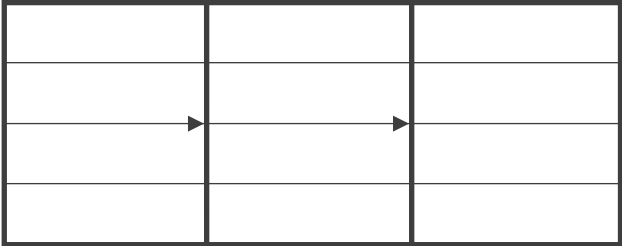
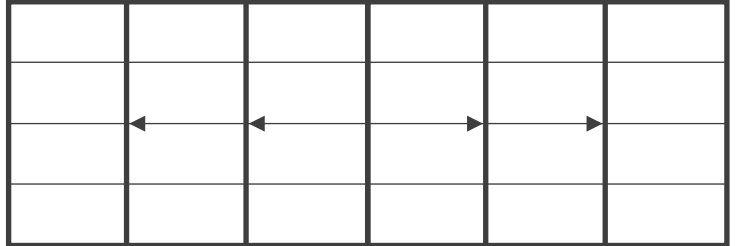
Size Code		21	27	30	32	36	48	54	42	53	64	
	O/A Reveal Size (mm)	2133	2673	2994	3213	3573	4833	5373	4188	5268	6368	
21	2110											
23	2370											
26	2660											

Please Note: Visible glass area between bars can vary in size across the same product, depending on product type, size and configuration. Speak to your A&L sales representative to find out more.

Please Note: Size charts are provided as a guide only, images may not reflect the exact proportions of the product you specify. Images represent the external view of the product and refer to A&L's standard offering for N2 areas. Specific size limitations or alternative options may be applicable for other wind categories or account customer specific ranges. The A&L website Terms of Use apply to this document. ALNAT0626/0724 July 2024.

Boutique French Doors

Lineage Collection – Loft Series

Code Prefix: DAFR Colonial Bar Pattern: Loft

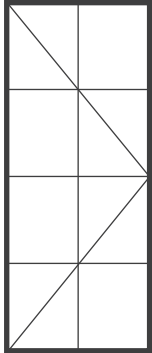
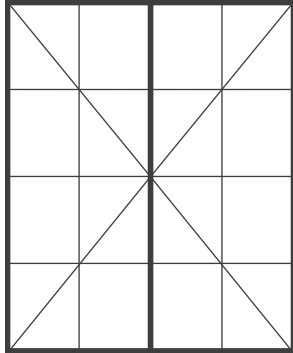
Size Code		06	08	09	10	11	12	15	17	19	21
O/A Reveal Size (mm)		648	768	898	1013	1113	1210	1450	1710	1940	2140
21	2110										
23	2370										

Please Note: Visible glass area between bars can vary in size across the same product, depending on product type, size and configuration. Speak to your A&L sales representative to find out more.

Boutique French Doors

Lineage Collection – Newport Series

Code Prefix: DAFR Colonial Bar Pattern: Newport

Double

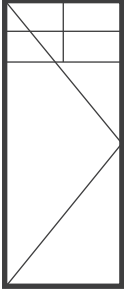
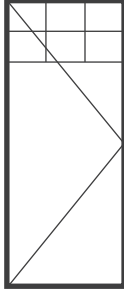
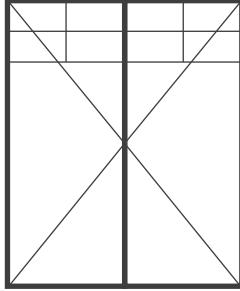
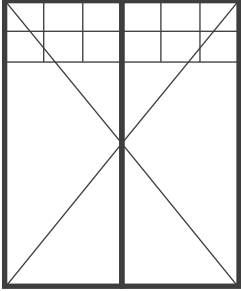
Size Code		06	08	09	10	11	12	15	17	19	21
	O/A Reveal Size (mm)	648	768	898	1013	1113	1210	1450	1710	1940	2140
21	2110										
23	2370										

Single

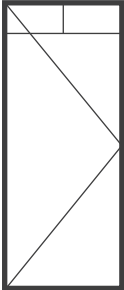
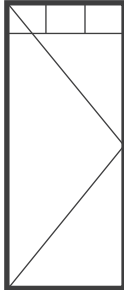
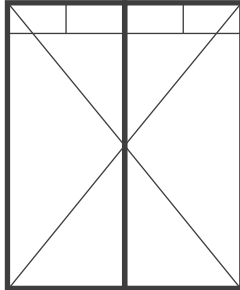
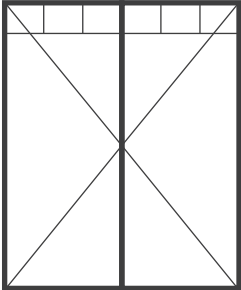
Size Code		06	08	09	10	11	12	15	17	19	21
	O/A Reveal Size (mm)	648	768	898	1013	1113	1210	1450	1710	1940	2140
21	2110										
23	2370										

Please Note: Visible glass area between bars can vary in size across the same product, depending on product type, size and configuration. Speak to your A&L sales representative to find out more.

Please Note: Size charts are provided as a guide only, images may not reflect the exact proportions of the product you specify. Images represent the external view of the product and refer to A&L's standard offering for N2 areas. Specific size limitations or alternative options may be applicable for other wind categories or account customer specific ranges. The A&L website Terms of Use apply to this document. ALNAT0626/0724 July 2024.

Boutique French Doors

Lineage Collection – Gatsby Series

Code Prefix: DAFR Colonial Bar Pattern: Gatsby

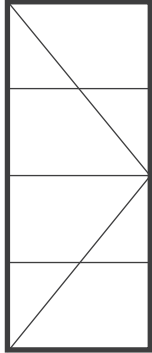
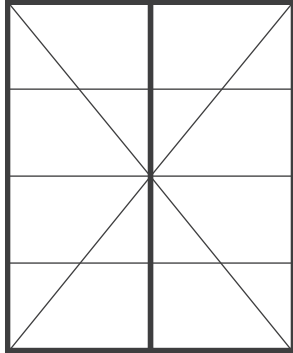
Size Code		06	08	09	10	11	12	15	17	19	21
O/A Reveal Size (mm)		648	768	898	1013	1113	1210	1450	1710	1940	2140
21	2110										
23	2370										

Please Note: Visible glass area between bars can vary in size across the same product, depending on product type, size and configuration. Speak to your A&L sales representative to find out more.